

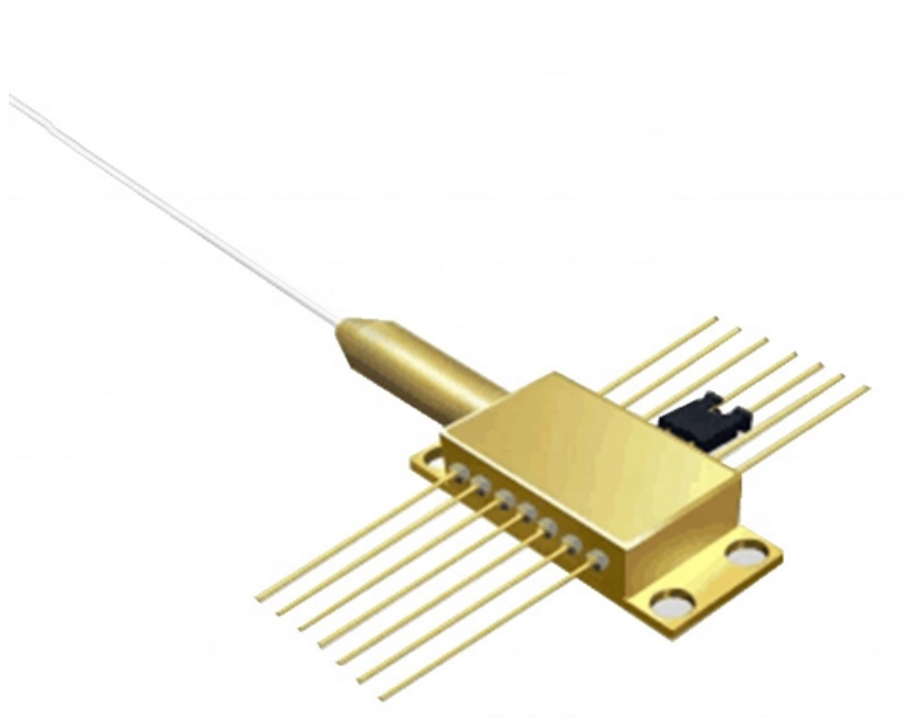

Adam Tas Corridor Energy

ADSS Optical Cable G 654 E





ADSS Optical Cable G 654 E



G.654.E Optical Fiber: Low-Loss, Large Effective Area

Compared to standard G.652.D fiber, G.654.E offers superior bend resistance and lower chromatic dispersion, making it ideal for 400G/800G

ADSS Cable Specifications G652D Fiber , PDF , Optical

This document provides specifications for an all dielectric self-supporting aerial cable (ADSS cable) produced by Shenzhen KSD Cable Co., Ltd. The cable uses single



ADSS fiber optic cable price , A Complete Buyer's Guide

Discover the latest ADSS fiber optic cable price for various spans and core counts. Get competitive quotes, understand cost factors, and choose the best solution for

Standard ADSS Fiber Optic Cable

AFL's ADSS (All-Dielectric Self-Supporting) fiber optic cable is designed for aerial installation without the need for messenger wire.



Lightweight, non-metallic, and

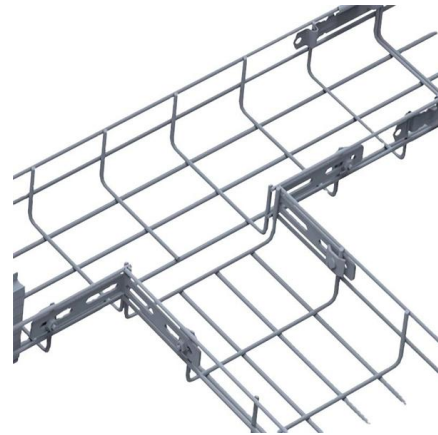

G654-E Fiber Cable Specifications , PDF , Optical Fiber , Optics

Design and special properties o Light, thin and particularly robust cable o Cable for direct burial, in applications with high mechanical loads and in areas with rodents o Stranded minibundle (loose tube)

What Are the Raw Materials of Fiber Optic Cables? Full

A complete guide to the raw materials of fiber optic cables--optical fibers, PBT tubes, FRP rods, aramid yarn, steel armoring, HDPE/LSZH jackets,

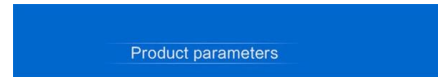

G652, G657A, G655, G654 Optical Fiber

G654: Ultra-low loss optical fiber, mainly used for transoceanic optical cables. The ordinary core is pure SiO₂, and the ordinary core needs to be doped



GL FIBER® G.654.E Bend-Insensitive Fiber

Demand of G.654.E fibre and cable is rapidly increasing in these years, it would contribute more for the improvement of optical network in future. GL FIBER's FarBand® Ultra delivers both advantages in a



Outdoor Fiber Optic Cable Types: Complete Guide

This article summarizes the major outdoor fiber optic cable types and their distinguishing features. You can Identify them with images.

Ficha_AR-1-FADPE-ADSS-60M-xxF-G652D

This Specification covers the design requirements and performance standard for the supply of optical fibre cable in the industry. ARTIC ensures a stable quality control system for our cable products

LoRawan outdoor base station



Non Metallic Armored Fiber Optic Cables , ETK Kablo

ETK Kablo's non metallic armored fiber optic cables are ideal for ADSS and dielectric network projects requiring high tensile strength, and EMI immunity.



G654-E Fiber Cable Specifications , PDF , Optical Fiber , Optics

G654-D Data Sheet v5 - Free download as PDF File (.pdf), Text File (.txt) or read online for free. Document of fibre



G.654.E Fibre Cable

Optical cables for telecommunications are highly engineered products designed to withstand both environmental conditions (e.g. aerial or underground exposure) and the specific mechanical stresses

Best 5 Fiber Optic Cable Manufacturers From China

Best Fiber Optic Cable Manufacturers From China Below, we profile the Best Fiber Optic Cable Manufacturers From China, highlighting each company's scale, capabilities, certifications, and unique

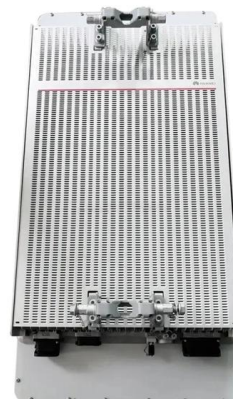

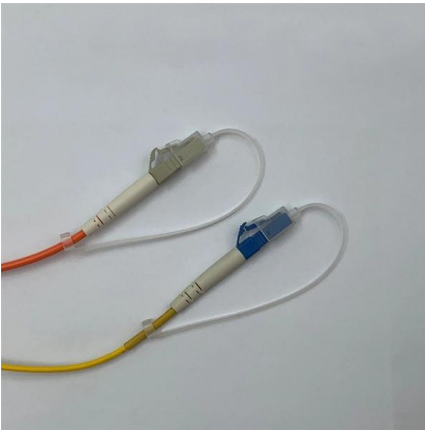

Multi-Loose Tube Fiber Cable

Outdoor dry core (ADSS) optical fiber Multi Loose Tube cable with aramid yarns as strength member and polyethylene outer jacket. Product feature: This cable has all dielectric and self-supporting

Ultra-low loss terrestrial long-haul fibers PureAdvance(TM) series

Ultra-low loss (ULL) optical fibers, PureAdvance(TM) series compliant with G.654.E, support high-capacity long-haul terrestrial networks. Employing pure silica core technologies, we promise to contribute to

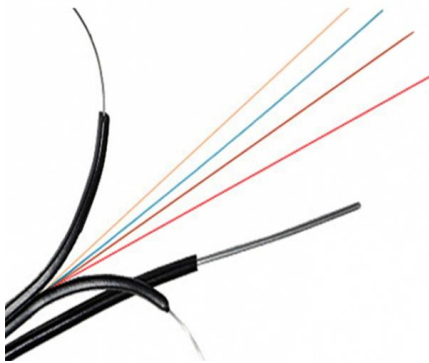

ADSS Cable China Manufacturer

Explore the complete guide to ADSS (All-Dielectric Self-Supporting) fiber optic cables: types, applications, installation tips, and cable selection. Zion

GL FIBER® G.654.E Bend-Insensitive Fiber

G.654.E fibre is featured with larger effective area and lower attenuation than normal fibre, and more suitable for long-haul transmission with high capacity and speed rate.



ITU-T G.654.E Fiber, PureAdvance for Terrestrial Long-Haul Networks

2. What is G.654.E? G.654.E fiber is a fiber featuring low attenuation and large core area, and is best suited for terrestrial long-haul and high-capacity transmission links.



SMF G652D G654E Standard IEC 61034 ADSS Anti Rodent Fiber

Product name:ADSS Optical Fiber cable;Application:Anti Rodent Fiber Optical Cable ;Certification:ISO9001;Jacket:PE/MDPE/HDPE;Span:50/80/100/120/150/160/200/300/400/500/800;Fiber

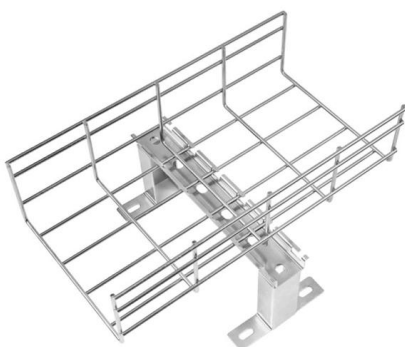

G.654.E Fibre Cable

Compared to conventional fibres such as G.652.D or G.655, G.654.E supports significantly higher bit rates over longer distances. When combined with coherent optical transmission technologies and



OYI INTERNATIONAL LTD

Oyi international., Ltd. is a dynamic and innovative fibre optic cable company based in Shenzhen, China. Since its inception in 2006, OYI has been dedicated to

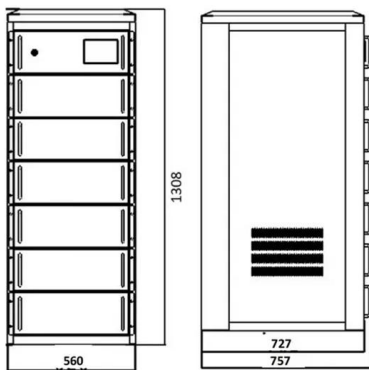

YOFC unveils connectivity solutions at 2024 MWC

Yangtze Optical Fibre and Cable Joint Stock Limited Company, a leader in the global optical fibre and cable market, showcased a suite of

Optical cable with ITU-T G.654.E fibre removes barriers to delivering

A new whitepaper from fibre cable experts ACOME Group and Sumitomo Electric Industries, Ltd. says that existing optical fibre cables will only be able to meet the long-term transmission capacity needs



What Is The Difference Between G.654E and G.654C

Free Samples Available: Test our G.654.E fiber and other products before bulk orders! For high-speed, low-loss optical transmission, G.654.E fiber is



Contact Us

For datasheets, pricing, or custom telecom energy solutions, please visit:
<https://www.koskolong.co.za>