



Adam Tas Corridor Energy

Automatic Welding Machine for Grid Cable Trays





Automatic Welding Machine for Grid Cable Trays



WyrGrid Overhead Cable Tray Routing System

Panduit offers industry-leading Cable Routing Systems as part of comprehensive, integrated Data Center Solutions to effectively manage and protect high-performance communication, computing,

Cable Tray Welding Machines

Cable Tray Welding Machines are specialized equipment designed for the automated production of cable trays, which are essential components in electrical and data

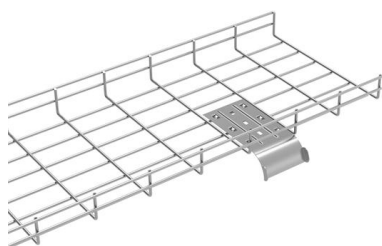

Automatic Robot Welding Machine for Steel Cable Tray

According to different customer needs, the industrial robot body, robot peripheral devices and existing equipment are coordinated and integrated to form an automated production unit.

How to make Cable Tray Mesh? Cable Tray Wire Mesh Welding Machine

This video will show the complete process of



manufacturing cable tray mesh using advanced welding machines. Watch how precision welding and automation technology transform raw materials into high



High Speed Cable Tray Making Machine, Capable of Producing Cable Trays

Fully automatic welding machine (double-sided servo trimming, peeling, hairless cutting machine), bottom net automatic welding equipment (automatic bending, stacking), K-net welding equipment for

Cable Tray Welder Machine with Automatic Wire Feeding

Featuring automatic welding, a user-friendly interface, and durable components,



Mastering Cable Tray Welding: Tips for Seamless Installations

Proper cable tray welding is crucial for structural integrity, safety, and functionality in modern electrical systems. Learn more now!





Shenkang Semi-Auto Type Grid Cable Tray Welding Machine

The Semi-Automatic Grid Cable Tray Welding Machine is designed for producing high-quality grid-type cable trays with improved efficiency and stable weld quality. It combines manual wire loading with

190X95X25mm



semi automatic cable tray panel fence spot welding

Transform your cable tray panel fence manufacturing operation with our semi-automatic spot welding machine. Contact us today to learn more about how this

Hebei Hanming Machinery Technology Co., Ltd

Grid bridge welding machine is an automated welding equipment specifically used for producing metal grid bridges. It adopts advanced resistance welding technology, especially with medium frequency

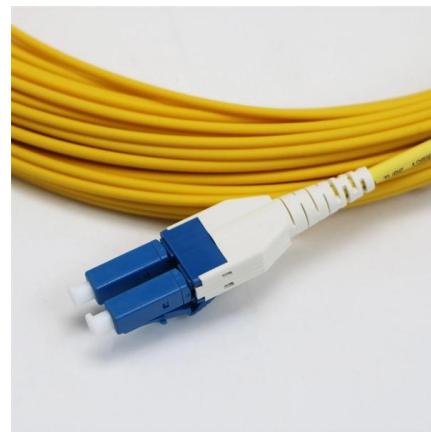

Cable trays for wind energy

Grid tray for use in the wind industry Duelco mesh trays are available in electro-galvanized, hot-dip galvanized, stainless steel 304 & 316 and in a zinc+ version and are ideal for routing cables on



Wire Mesh Cable Trays , Welded Steel Cable Trays

Madsen Steel Wire manufactures custom, welded steel cable trays for use in many industrial and commercial settings. Our capabilities also include sheet metal and

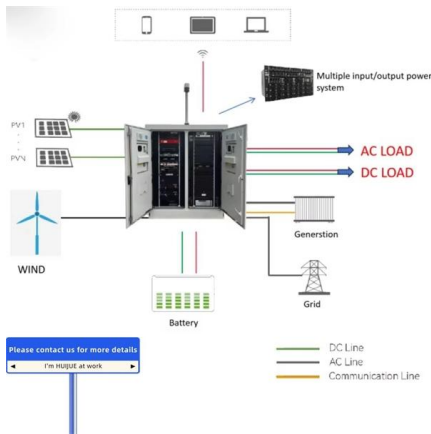

Cable Tray Making Machine

For manufacturers looking for special designs and cross-sections, customized cable tray making machines deliver unique profiles. Addition of specialized processes like center spine forming,

Understanding Grid Cable Trays and Their Applications

Explore the applications, benefits, and features of grid cable trays in industries like manufacturing, data centers, and residential homes. Learn how to



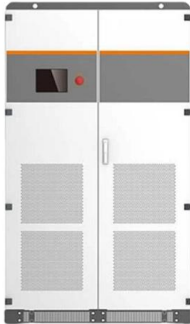

How to build Cable Tray , Wire Mesh Cable Tray Welding Machine

In this video, I will show how to build cable tray wire mesh with a wire mesh welding machine. ---RKM MachineryDo you know how many steps are needed to make

Fully Automatic Cable Tray Wire Mesh Welding Machine PLC Control

The cable tray welding machine is used for automatic welding of cross bars and frames in cable trays. It is widely used in power, telecom, and construction industries.



Automatic Cable Tray Production Machine for Cable Management DAPU

The cable tray welding machine is used for automatic welding of cross bars and frames in cable trays. It is widely used in power, telecom, and construction industries.

Cable Tray Welding Machine

Cable tray welding machines are specialized equipment designed for the automated production of cable trays, which are essential components in electrical and data cable management systems. These

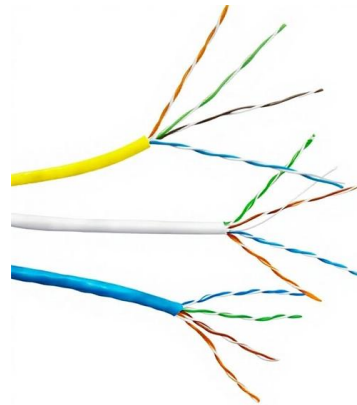

Grid welding machine and method for producing wire grids

The grid welding machine according to claim 14, wherein power supply units provided for supplying power from the stationary transformers to the electrodes and counter electrodes are configured as



Automatic Robot Welding Machine for Steel Cable Tray

- 1. Workstation name: Ladder-type cable tray double-station robot welding workstation
- 2. Required quantity: 1 set
- 3. Workstation composition: welding robot (SF62000), welding machine (NDC350),



Cable Tray Mesh Welding Machines

Clifford introduces their state of the art fully automatic Cable tray welder. The line is capable of welding all three common cable trays, such as Lapp welded, T-welded





Stainless Steel Cable Tray Mesh Welding Machine , Automatic

Key features of the machine: Automatic wire feeding system Precise mesh spacing control High welding strength Stable continuous production Cable tray mesh is commonly used for: o Electrical

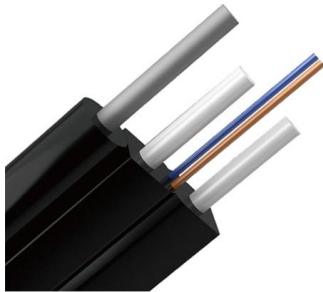

Cable Tray Mesh Welding Machine (RKM-FP-1000A+) , RKM Machinery

The cable tray mesh machine is specialized equipment designed to produce welded metal meshes used in cable trays. These meshes

Automated high-speed steel grid wire mesh welding machine

Automated high-speed steel grid wire mesh welding machine Widely used for multiple spot welding of various fences, hardware nets, shelves, cages, wire racks, steel plate reinforcement bars, etc.

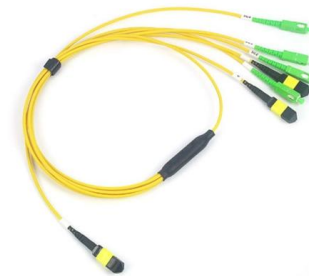

Cable Tray Welder Machine with Automatic Wire Feeding

Featuring automatic welding, a user-friendly interface, and durable components, this machine is ideal for manufacturing heavy-duty cable trays used in construction,



Comprehensive Guide to Cable Tray Production Equipment

Cable tray production equipment refers to the machinery and tools used to manufacture cable trays, which are structural components designed to

LoRawan outdoor base station

- * Industrial Internet gateway
- * Compatible with LoRaWAN network,
- * ClassA/B/C mode
- * Support 8/16 channel
- * Supports PoE power
- * supply and backup battery power supply
- * 10KV lightning protection

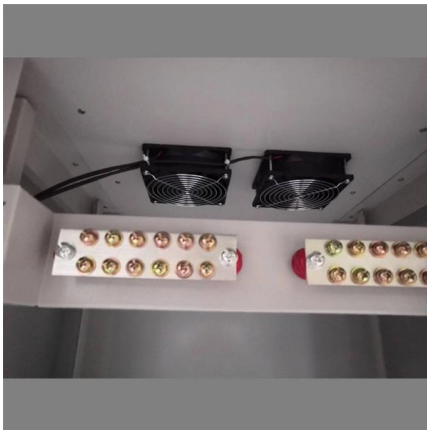

Full Automatic Welding Machine for Perforated Cable Trays

Featuring automatic welding, a user-friendly interface, and durable components, this machine is ideal for manufacturing heavy-duty cable trays used in construction, electrical, and telecommunications

Cable Tray Mesh Welding Machine

With its efficient pneumatic welding system, this machine ensures high-quality, durable mesh that is essential for organizing and protecting cables, offering a reliable solution for wiring management in





C-grid cable trays

C-grid cable trays are used in the chemical, food and pharmaceutical industries, in agriculture, building services engineering, power plant construction and many



Contact Us

For datasheets, pricing, or custom telecom energy solutions, please visit:
<https://www.koskolong.co.za>