



Adam Tas Corridor Energy

CIF Price of Upgraded Energy Storage Cabinet Exported by Slovakia





CIF Price of Upgraded Energy Storage Cabinet Exported by Slovakia



Slovakia Energy Storage Market (2025-2031) , Industry & Size

The Slovakia Energy Storage Market is experiencing growth driven by the country`s increasing focus on renewable energy sources and the need to integrate intermittent sources like wind and solar into the

The EU is supporting the modernisation of a major

The Connecting Europe Facility for Energy (CEF Energy) is supporting the studies with a grant of more than 2.1 million euros for the

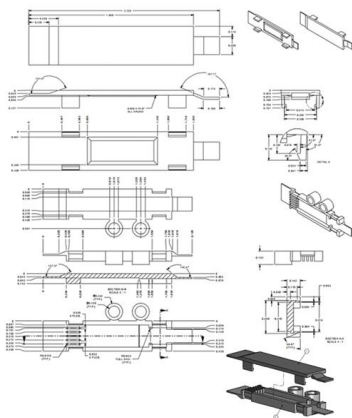

Research RES LEGAL - Support system Country: Slovakia

[spx?HitFile=True& FileID=329& Flags =160& IndexFile=zz2009& Text=309/2](#)

National Report

Message from the Chairman The year 2021 cannot be judged otherwise than in terms of the impact of the second year of the COVID-19



pandemic, both on the citizens and the economy of the Slovak

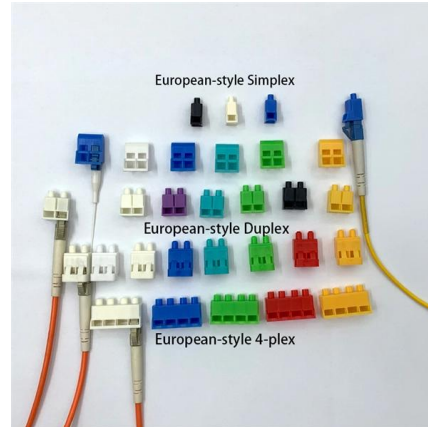

Slovakia Energy Storage Market (2025-2031) , Industry & Size

Slovakia Energy Storage Market Top 5 Importing Countries and Market Competition (HHI) Analysis
Slovakia`s energy storage import Market Top 5 Importing Countries and Market Competition (HHI)



Ranking of Bratislava Energy Storage Companies: Who's Powering Slovakia

That's Bratislava in the European energy storage game. With 42% annual growth in renewable energy adoption since 2022 , Slovakia's capital needs robust storage solutions to keep its lights on



average industrial battery cabinet price per 10MWh in Slovakia

The cost of a 10 MWh (megawatthour) battery storage system is significantly higher than that of a 1 MW lithiumion battery due to the increased energy storage capacity.





Slovakia Energy Storage Systems Market (2025-2031) , Revenue

The Slovakia Energy Storage Systems Market is poised for significant growth in the coming years due to several factors, including increasing renewable energy integration, grid modernization efforts, and



Top 13 Energy Storage Companies in Slovakia (2026)

Damas Energy, the sole operator of the electric transmission system in Slovakia, plays a crucial role in ensuring stable electricity transmission from various

Energy Storage Opens a New Chapter for Inverters

The sharp fall in lithium carbonate prices since 2023 has further accelerated this process, driving a significant drop in the cost of energy storage



Slovakia Energy Storage Tank Price Trends: 2024 Market Analysis

Discover the latest price dynamics of energy storage tanks in Slovakia and how renewable energy policies are reshaping the market.

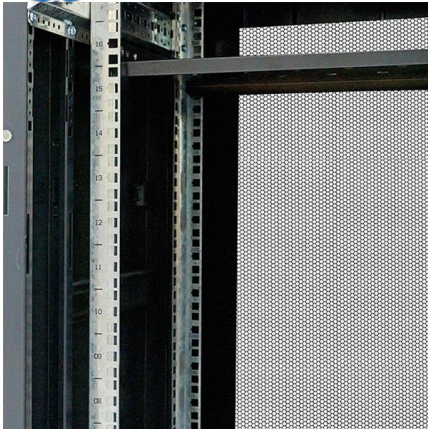

Energy storage cabinet import and export analysis to

With the global energy transition and the wide application of renewable energy, the import and export business of energy storage cabinet, as

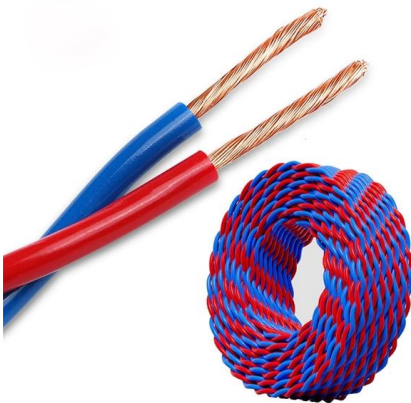
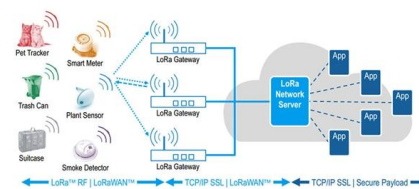

Slovakia Heavy Industry Energy Storage Cabinet Quote: Solutions for

With Slovakia's industrial electricity prices projected to rise 8-12% by 2025, implementing energy storage cabinets isn't just about sustainability - it's becoming a financial necessity.

Europe's Energy Storage Boom: How Exporters Can Tap into the

Let's cut to the chase: Europe's energy storage market is growing faster than a Tesla battery on supercharge. With 65GWh of cumulative installed capacity as of April 2024 and projections hitting





Wholesale Electricity Price Projections for Slovakia

Slovakia is located at the crossroads of Central and East Europe, and is an important transit country for electricity Surplus generation, mainly from RES-E in Germany (e.g. wind energy) is exported through

Slovak Republic 2024

The Slovak Republic's industry sector is dominated by energy-intensive industries that are highly vulnerable to energy price shocks. Since 2021, the country has seen reduced industrial production

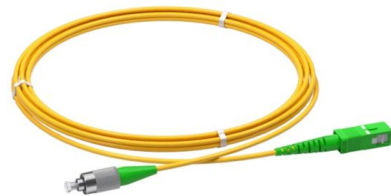

Energy Resource Guide

Slovakia - Renewable Energy Take advantage of our market research to plan your expansion into the renewable energy market in Slovakia. This guide includes information on: Current market needs, The

PRICE OF CONTAINERIZED ENERGY STORAGE CABINETS IN

The highest energy efficiency ratio of wind and solar energy storage power station Clean energy sources like wind and solar have a huge potential to lessen reliance on fossil fuels.



Latest developments in the electricity sector in Slovakia

Slovakia's energy mix in 2022: share of individual energy sources in total electricity generation (defined according to Energy Act)
Slovakia's future energy mix will take into account three pillars - security



Photovoltaic energy storage slovakia

Slovakia's renewable energy targets and strategy. Slovakia's National Energy and Climate Plan sets an ambitious target of achieving a 19.2% share of renewable energies in gross final energy consumption



SLOVAKIA ENERGY STORAGE SYSTEMS MARKET 2025 2031

A battery energy storage system (BESS), battery storage power station, battery energy grid storage (BEGS) or battery grid storage is a type of technology that uses a group of in the grid to store .





Slovakia Renewable Energy

Slovakia adopted a new clean energy and co-generation support scheme - introduced by an amendment to the Act on Support of Renewable Energy Sources and High Efficiency



The Rising Tide of Professional Energy Storage Cabinet Exports:

Why the World Can't Get Enough of Energy Storage Cabinets 105 giant battery-packed metal boxes sailing from Shenzhen to Chile, each capable of powering entire neighborhoods. This isn't sci-fi - it's

Slovakia Energy Storage Project Bidding: Opportunities and Strategies

With a national target to achieve 19% renewable energy by 2030, the country is actively seeking partnerships to build grid-scale battery storage systems. Let's break down what this means for



New Market Opportunities: Slovakia's 2025 Energy Storage Projects

With EUR500 million in planned investments and tax incentives sweeter than Slovakian honey cake, the government's push for battery storage and hydrogen solutions is creating a gold



ENERGY PROFILE Slovakia

Onshore wind: Potential wind power density (W/m²) is shown in the seven classes used by NREL, measured at a height of 100m. The bar chart shows the distribution of the country's land area in each



Slovakia (SVK) Exports, Imports, and Trade Partners

In December 2025 Slovakia exported \$8.31B and imported \$8.26B, resulting in a positive trade balance of \$44.1M. Between December 2024 and December 2025

Renewable energy in Slovakia , CMS Expert Guides

Are you looking for information on renewable energy in Slovakia? In this CMS Expert Guide, we tell you everything about it.



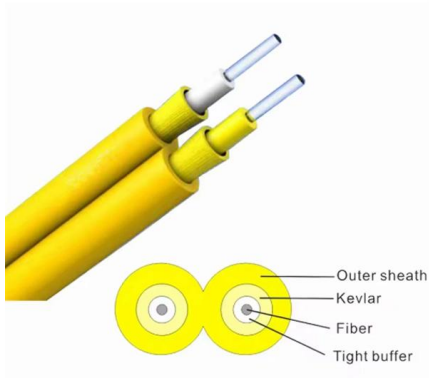

Top 13 Energy Storage Companies in Slovakia (2026)

The Energy Storage industry in Slovakia presents several key considerations for potential entrants and investors. One major factor is the regulatory framework,

Contact Us

For datasheets, pricing, or custom telecom energy solutions, please visit:
<https://www.koskolong.co.za>