



Adam Tas Corridor Energy

Cambodia High-Voltage Cast Busbar Manufacturing





Cambodia High-Voltage Cast Busbar Manufacturing



DBTS Industries Sdn Bhd (604609-V)

With our advancements in R& D, Manufacturing Processes, and Quality Control, DBTS has perfected our unique thermoset blu-E-Coat epoxy insulation and Cast

Ohory Electric Busway

Our products are rigorously tested for IP65-IP68 protection, high ambient temperatures, and seismic resistance, making them ideal for data centers, high-rise buildings, rail transit, shipyards, substations,

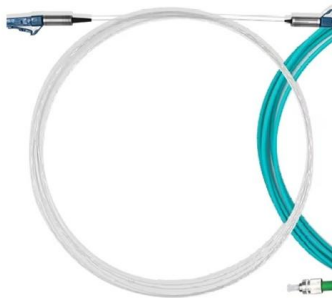

2022-56(1)-1.vp

Cast resin busbars are widely used in power plants and substations to facilitate compact installation of high-voltage complexes and devices, helping to ensure the reliable operation and long service life of

Busbar Systems , Power Busbars , EAE Electric

Power Busbar Systems are designed for the safe transport and distribution of electrical energy,



ranging from 32A to 6300A, ensuring efficiency and reliability.



CATALOG WavePro-R Cast resin busway

WavePro-R Busway Overview ABB WavePro-R Cast Resin Busway is a high performance low-voltage busbar system. The cast resin forms an external surface which provides a water tight barrier around

Cambodia Busbar Market (2025-2031) , Trends, Outlook & Forecast

The Cambodia Busbar market faces several challenges that affect its growth and competitiveness within the electrical industry. One significant challenge is the limited availability of standardized busbar

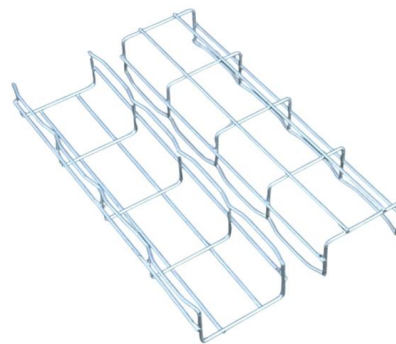

PESTEC (Cambodia) PLC - GLOBAL ELECTRICAL

We offers the design, engineering, manufacturing, installation, testing and commissioning of high voltage ("HV") and extra high voltage ("EHV") substations,



High-Voltage Busbars

As a rule, multi-stage production processes are required to manufacture busbars. In the development of such a component, the material behavior, the different manufacturing processes (punch-bending,



Busbars , Busbars manufacturers & supplier , Eaton

Our primary manufacturing processes include progressive stamping, Computer Numerical Control (CNC) bending and our RigiFlex(TM) technology that delivers

Medium Voltage Busbar , MV busbar 12-17,5 kV , EAE

Medium Voltage Busbar Systems are manufactured for power transmission and distribution requirements in high-security structures and facilities. The MV Cast



High-Voltage Busbars

Powering tests of the busbars simulate driving cycles and charging cycles under different climatic conditions in a particularly sharp form. In doing so, large temperature differences and changes are



Cast Resin Insulated Busway System

The busbar consists of copper or aluminium conductors, embedded in an enclosure of a fire retardant, self extinguishing and homogeneous insulation mix based on epoxy cast-resin with mineral fillers,

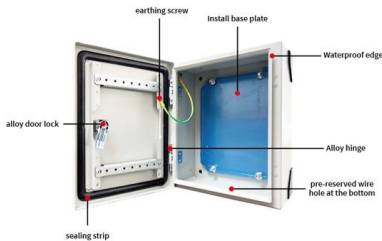
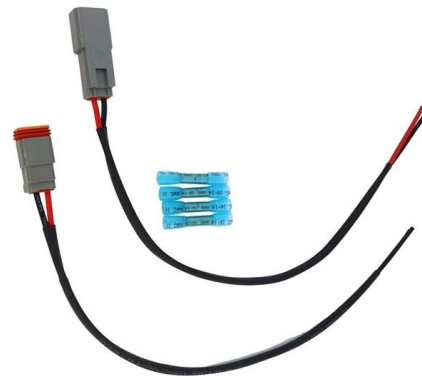

Medium Voltage Busway MV Cast Resin Insulated Busway (Copper)

As a leading manufacturer of Busway (Busbar Systems), our products have a reputation for quality. TECOBAR Medium Voltage Cast-Resin Insulated Busway is developed for power systems

Technological Aspects of the Use of Cast Polymer Insulation for High

Special high-voltage busbar (current carrier) designs are widely used to connect various objects in stations and substations (generators, transformers, switchgear, etc.) and individual





Busbar Manufacturing

Busbar Manufacturing At Datum, we specialise in custom, thin metal, busbar manufacturing, delivering precision copper, aluminium, nickel and nickel plated

30 Busbar Manufacturers in 2026

This section provides an overview for busbars as well as their applications and principles. Also, please take a look at the list of 30 busbar manufacturers and

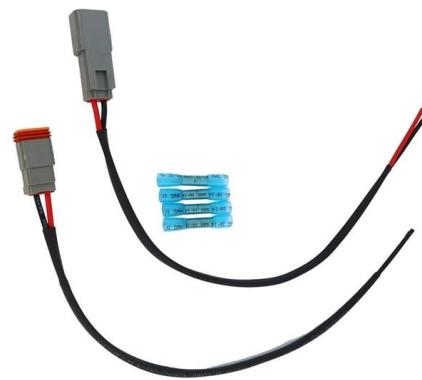

High Voltage Busbars by Intercable Automotive Solutions

High volume busbar production: employing craft precision. One of the signature products developed by Intercable Automotive Solutions are our custom made

Busbar Fabrication: Techniques for Efficient Assembly

This article delves into the intricate processes behind busbar fabrication, detailing the techniques and tools necessary for efficient assembly.



8-Port PLC Fiber Splitter Box
12-Port SC Fiber Splitter Box

Size: 235*215*75mm
Material: ABS, IP65,



Busbar in Cambodia , Best Busbar from Cambodia , Buy

Discover a wide selection of high-quality Busbar in Cambodia from trusted suppliers. Explore our range of Best Busbar from Cambodia and find the perfect fit for your needs.

ABB WavePro R

ABB WavePro-R Cast Resin Busway is a high performance low-voltage busbar system. The cast resin forms an external surface which provides a watertight barrier around the current carrying conductors.

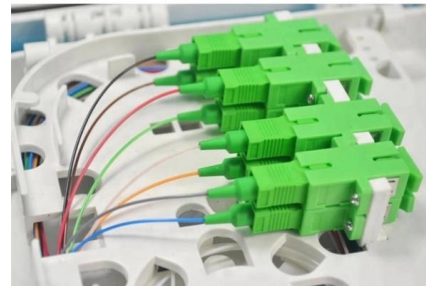

Dimensions:

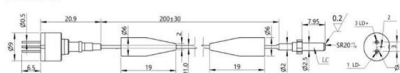

EUROBAR Cast Resin insulated busducts (solid)

EUROBAR Cast Resin insulated busducts (solid insulated busbar) EUROBAR Cast Resin insulated busducts are used for connecting of the low voltage units in the



Sector Brief Cambodia: Electrical and Electronic Equipment Industry

Source: Cambodia in the Electronic and Electrical Global Value Chains (CDRI, 2019) Cambodia has seen the emergence of its own EEE industry in recent years. Its manufacturing capabilities date back



Ohory Electric Busway

Ohory Electric , Leading Manufacturer of Busduct Systems & Cast Resin Busways Ohory Electric is a top-tier busway manufacturer in China, specializing in cast

Bus Bars , Power Solutions

We provide sales, engineering and manufacturing support from our facilities in North America, Europe and Asia. Our experienced teams of applications engineers,



CAST-RESIN BUSWAY SYSTEMS INSULATED

TECOBAR Product Description: The product Low Voltage features Cast-Resin Insulated of safety Busway is developed for electrical systems cast resin sealing to the copper contains non-organic



Busbar-JONVER

Busbar Description Busbars serve as the primary electrical connections in high-voltage (HV) systems, linking cells and modules while providing a pathway to the



MV Busbar System - Grid Consulting

Medium Voltage Busbar System is manufactured for power transmission and distribution requirements in high secure structures and plants. Medium Voltage

Bus Bars , Power Solutions

Telecommunication Data Router Assembly Laminated Bus Bar Saves Product Launch Powder Coated This durable insulator withstands a high voltage dielectric





CE Certification Custom Busduct Cambodia Suppliers, Manufacturers



When it comes to efficient power distribution, our Busducts in Cambodia stand out for their custom solutions tailored to meet your specific needs. With years of experience as a trusted supplier and

Contact Us

For datasheets, pricing, or custom telecom energy solutions, please visit:
<https://www.koskolong.co.za>