

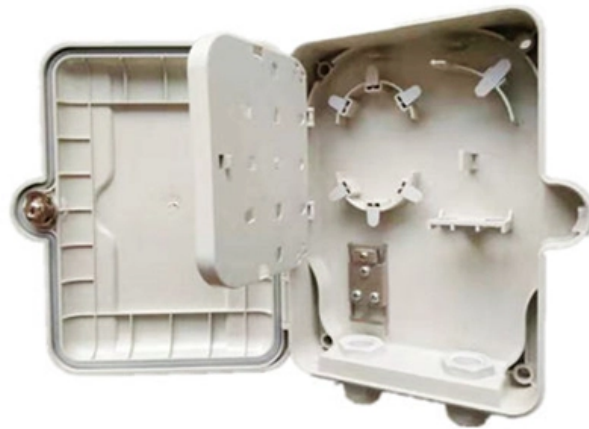

**Adam Tas Corridor Energy**

# **Cold Aisle Installation Price for Computer Room**





## Cold Aisle Installation Price for Computer Room

---



### Data Centre Cooling: Hot Aisle and Cold Aisle Design

The hot aisle/cold aisle configuration ensures a consistent supply of cool air, reducing the likelihood of equipment failures due to overheating. Better airflow

### Cold Aisle Containment Systems , Server Room Environments

Looking for cold aisle containment systems and POD related products? The Server Room Environments projects team provides a complete design, installation and maintenance service for data centre



### Data Center Aisle Containment

Based on our typical 500kW installation, an open aisle data center will operate in full free cooling mode for just 1% of the year, with a requirement for some form of

### Data Center Cooling Costs & How To Reduce Them

Modern liquid cooling systems can cost between \$1,000 and \$2,000 per kW cooled. Add that to



the initial investment cost, and potential consulting



### **Cold Aisle Containment in Data Centers , Subzero**

Minimize your data center's footprint, establish optimal operating efficiencies and save money with cold aisle containment. Learn more here!

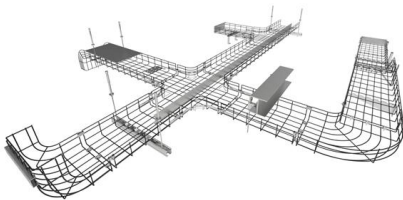

### **Explore hot and cold aisle containment for your data center**

Hot and cold aisle containment can help you maintain the best air flow, temperature and humidity in the data center to keep servers running efficiently.



### **Hot and Cold Aisle Containment Solutions Ardmac**

Get expert hot and cold aisle containment solutions for your data centres with Ardmac. Our tailored approach maximises efficiency.

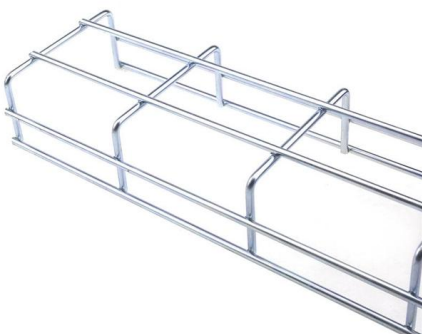



## Data Center Hot/Cold Aisle Containment Systems , Eaton

An aisle containment system is a simple way to improve cooling efficiency in hot aisle/cold aisle rack configurations. Essentially creating a room within the aisle,



## Hot and Cold Aisle Containment: What You Need to

Aisle containment is a physical means of separating hot (exhaust) and cold (supply) air. It can be accomplished via thoughtful room design, cabinet

## Cold Aisle Containment

Cold Aisle Containment or CAC is a proven, relatively easy to deploy solution for effectively managing airflow within a data centre. A CAC system surrounds the



## Optimizing Data Center Cooling for Energy Efficiency

Disadvantages of Cold Aisle Containment Hotter Overall Room Temperature: The data center space outside the contained aisles becomes the



## Cost-Effective Data Center Containment Installation

Cold Aisle Containment (CAC): Cold aisle containment focuses on isolating the cold supply air, directing it specifically to the IT equipment, and

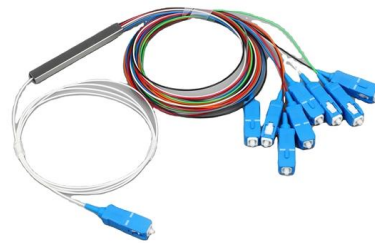

## Aisle Containment , Modular Cleanroom & Data Center Containment

Enhance airflow control and energy efficiency in data centers, laboratories, and cleanroom environments with Armstrong Aisle Containment Ceilings & Walls. Our modular systems

## Data Center Cooling Costs & How To Reduce Them

Data Center Temperature Settings Simply raising the cold aisle temperature can significantly reduce energy use. There generally isn't a need to



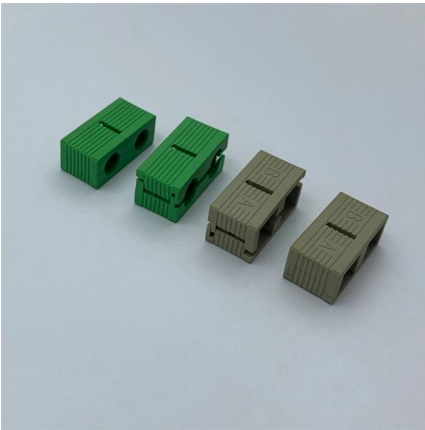

## Cold Aisle Containment

How Cold Aisle Containment Works The cold aisle containment system encloses the cold aisle and prevents the mixing of cold air with hot exhaust air. This lets hotter

## Aisle Containment for Server Rooms and Data Centers

Shop aisle containment solutions at Server Racks Online. Explore hot and cold aisle containment systems, including doors, panels, and ceilings. Improve data center airflow, cooling efficiency, and

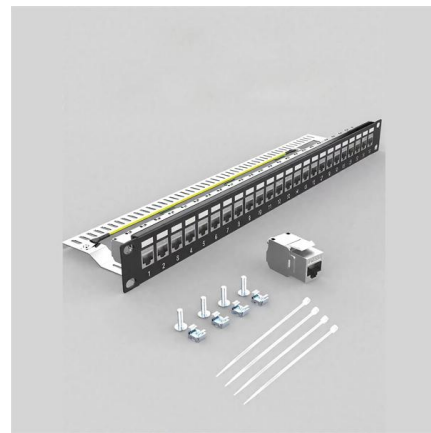

## Optimizing Data Center Cooling: The Power Of Hot And

Discover how to optimize your data center cooling system with hot and cold aisle containment. Learn about the assessment, design, installation, and

## Data Center Cooling

How are data centers cooled? find out in this video on how data centres are cooled. covering CRAC units, cold aisle containment, hot aisle containment, susp



### **Cold Aisle Containment**

If properly installed you can expect 20-50% reduction in cooling costs. Efficiency is maximized if the cooling systems with variable speed fans and there is a good

### **Hot / Cold Aisle Containment**

Sliding Doors offer data centers aisle-end containment in just minutes and without the need for contract labor. The one-tool design allows for quick and easy



### **Data Center Curtains , Hot & Cold Aisle Containment**

Data Centers and Equipment Rooms Anti-Static Data Center Containment Curtains, Doors, and Partitions - The Ideal Solution for Data Centers  
Data center managers

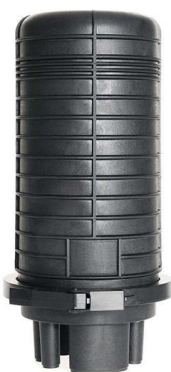



## Hot & Cold Aisle Containment Systems For Data

Cool Shield(TM) products provide customers with versatile, turnkey aisle containment systems for new or existing critical spaces. Our offerings range from a single row



## Hot / Cold Aisle Containment

Hot / Cold Aisle Containment AisleLok Upsite AisleLok containment solutions and portfolio of aisle airflow management products are designed to improve cooling

## Data Center Hot/Cold Aisle Containment Systems , Eaton

The components are organized into modular kits and come with assembly hardware for easy step-by-step installation. Depending on your hot-aisle/cool-aisle needs,



## How to Keep Your Server Room Cool

Due to the physics of air (cold air sinks while hot air rises), servers at the top of the frame could still overheat. Installing perforated floor panels in cold



## Contact Us

---

For datasheets, pricing, or custom telecom energy solutions, please visit:  
<https://www.koskolong.co.za>