

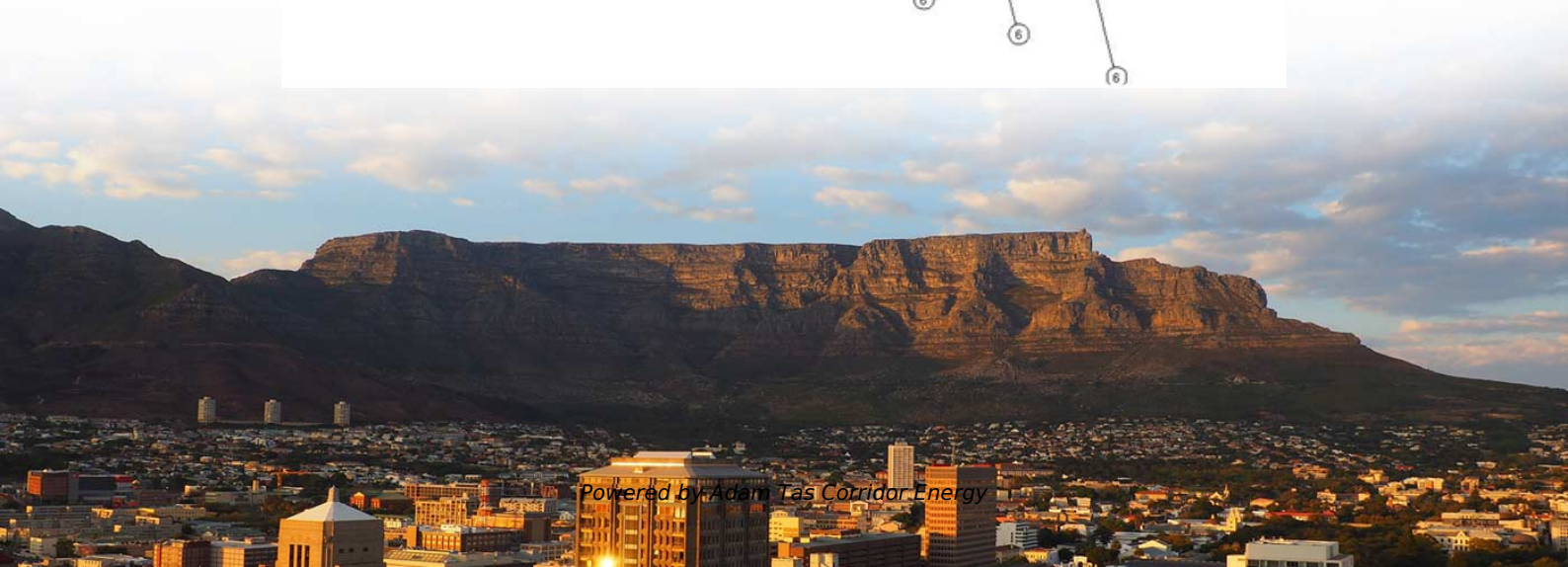

Customized equipment for optical cable production processes

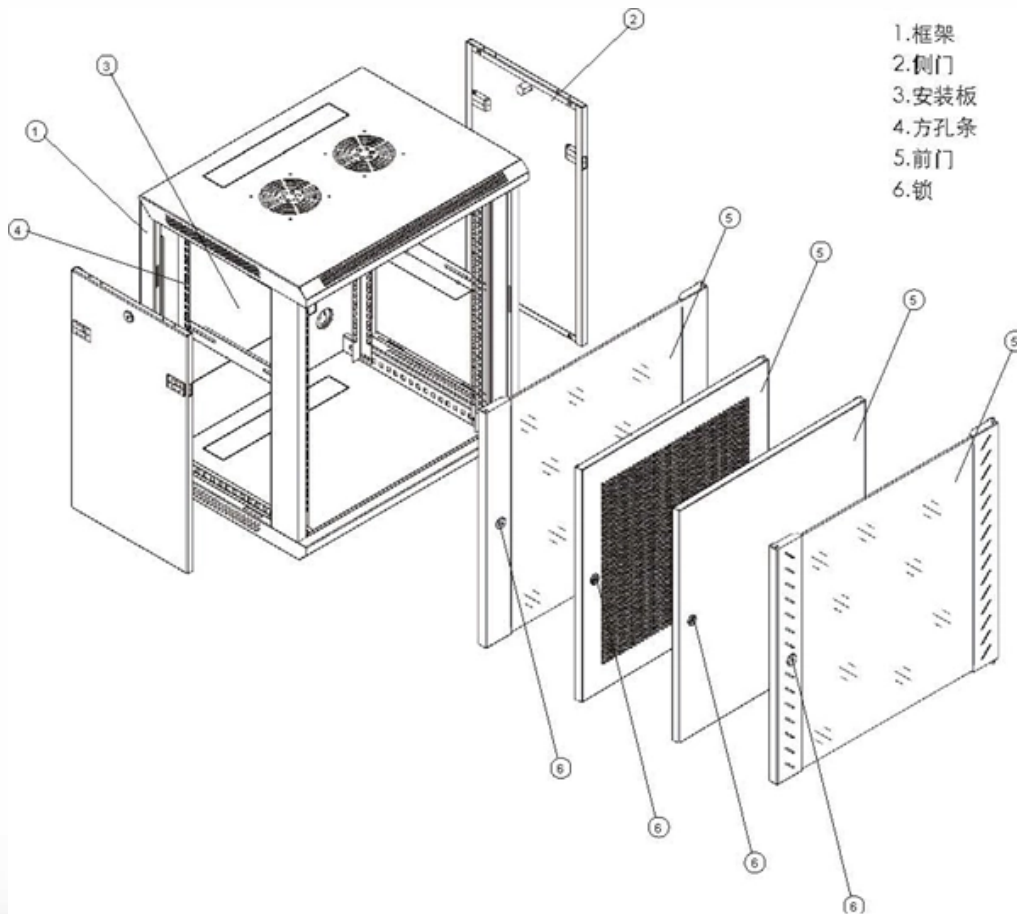



Customized equipment for optical cable production processes



The Complete Guide to Fiber Optic Cable Manufacturing: Powering

At Sinoptec, our advanced manufacturing processes ensure each fiber meets rigorous industry standards for telecommunications and enterprise networks. Multi-mode fiber, with its larger

Fiber optic cable materials and production equipment

Reinforcing vital cables Fiber optic cables connect societies across the globe. That requires strong reinforcement. We process the reinforcement fibers, that protect



Customized OEM Fiber Assemblies & Fiber Optic

Our production is designed for both standardized and highly complex OEM assemblies, covering everything from single fibers to customized multi-fiber

Fiber Optic Cable Manufacturing Process: A Detailed Overview

Fiber optic cables have revolutionized data transmission, providing high-speed, reliable communication over long distances. The



manufacturing of these cables is a complex process that



Optical Cable Manufacturing: A Deep Dive into the Process

Explore the optical cable manufacturing process. Learn about raw materials, fiber drawing, cabling, and quality control in modern optical cable

Optical Cable Production Line: Revolutionizing Global Connectivity

Conclusion The optical cable production line has transcended its role as manufacturing infrastructure to become a strategic differentiator in the global technology race. As 6G, quantum



Premier Cable Machine Manufacturer - HONGKAI

Guangdong Hongkai Optical Cable Equipment Technology Co. Ltd is a specialized provider of high-quality cable manufacturing equipment, renowned for delivering exceptional performance and



30 Types of Optical Cable Production Equipment

Explore 30 essential types of production equipment used in optical cable and fiber optic assembly manufacturing. Learn how these machines enhance efficiency



Advancing Optical Cable Production Lines: Automation, Quality

The optical cable industry stands at the forefront of digital transformation, with global production volumes exceeding 600 million kilometers annually. As 5G networks, hyperscale data

A Guide to Optic Fiber Cable Equipment - InsightInitiative

FTTH Cable Manufacturing Line Solutions & Equipment The worldwide need for fiber optic internet is expected to surpass 50 billion-plus connections by 2025, signaling a significant shift in the

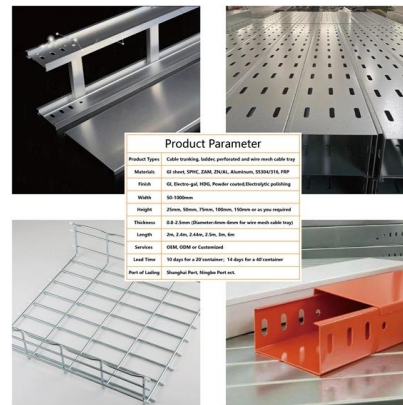

Future-Proofing Networks Exploring the Evolution of Fiber Optical Cable

Customer satisfaction is paramount at OWIRE, and this is reflected in their stringent quality control processes. From the initial design phase to the final inspection, every aspect of the



Premier Cable Machine Manufacturer - HONGKAI

If you are looking for a professional manufacturer who makes Optic Cable, Electric Cable, and Network Cable machines, you are in the right place. HONGKAI group opened its door in 2005 as an optic



Custom Fiber Optic Cables

Rather than ordering OEM or off-the-shelf fiber optic cables with no customization and having to adapt them on the fly to your project, or trying to manufacture

Turnkey Optical Cable Production Solution

Turnkey optical cable production--from planning to support. Enjoy transparent pricing, risk management, and fast ROI.

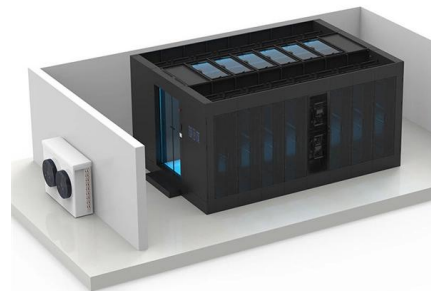



optical cable production line: High-Speed Manufacturing Solutions

Discover advanced optical cable production line equipment for efficient, high-speed manufacturing. Explore PLC control, automated splicing, and real-time defect detection. Click to find top-rated

Production equipment for fiber optical cables (FOC)

Rosendahl Nextrom - tailor-made equipment for fiber optical cable production. Complete FOC manufacturing solutions, from fiber to finished cable, as well as individual solutions for the



POF Processing , Schäfer Group

Are you looking for an experienced partner for the manufacturing of machinery and equipment for the production of fiber optic cables? Schäfer offers you a wide

Production Equipment , Connected Fibers , Fiber Optic manufacturing

Manufacturing Equipment Manufacturing Equipment for Fiber Optic Cable Assembly Manufacturing including Patch Cords, Pigtailed, and Terminated Devices Epoxy Dispensers and Vacuums

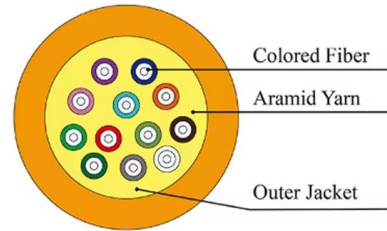

Fiber Optic Cable Production Line Solutions

Complete Fiber Optic Cable Production Line Solutions Maximize efficiency with our advanced manufacturing equipment. Achieve 30% output boost, 28% energy

Cable Machinery & Production Lines , HONGKAI Solutions

Discover HONGKAI's complete range of cable machinery, fiber optic production lines and raw materials for all your cable manufacturing needs.

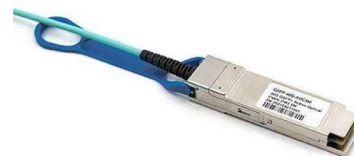

Fiber optic cable materials and production equipment

Roblon's long-term experience and knowledge of cable fibers and cable machinery offer our customers a wide range of benefits, as we hold the necessary expertise



Customized OEM Fiber Assemblies & Fiber Optic

Custom OEM Fiber Assemblies - Precisely Matched to Your Application Tailored OEM Solutions - When Standard Isn't Enough Industries such as medical

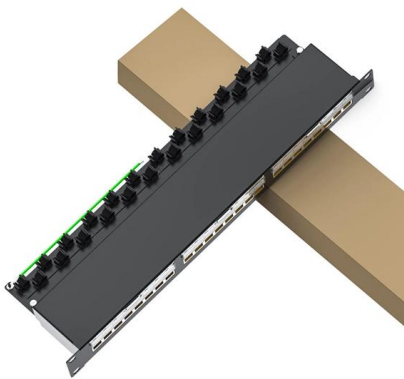

Key Optical Fiber Manufacturing Equipment: A Complete Guide

Learn about key optical fiber manufacturing equipment like drawing towers, coating systems, and proof testers to optimize your production line.

Tools & Equipment for Fiber Optic Patch Cord Production

Explore essential tools and equipment for producing high-quality fiber optic patch cords -- from curing ovens to polish machines and end-face detectors.



Contact Us

For datasheets, pricing, or custom telecom energy solutions, please visit:
<https://www.koskolong.co.za>