



**Adam Tas Corridor Energy**

# **Fiber optic fusion splicer capable of connecting G652 optical cables**

## **STAINLESS STEEL WIRE MESH**

Long-lasting and durable

Comprehensive specifications

Customized non-standard products

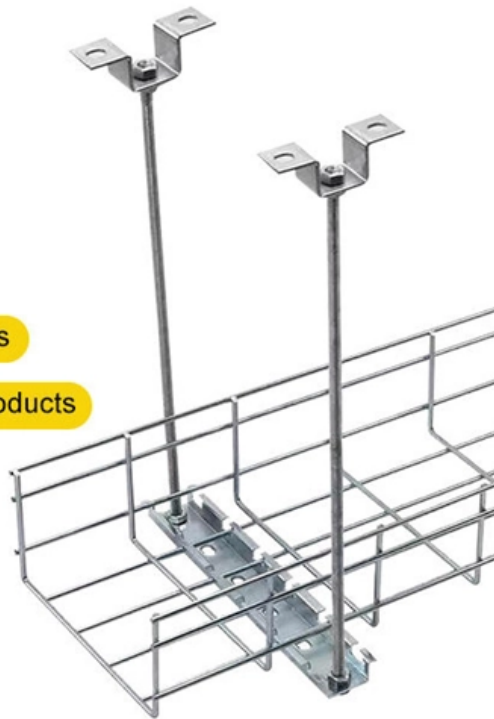



## Fiber optic fusion splicer capable of connecting G652 optical cables

---



### What Is A Fusion Splicer Machine. Optical Fiber Fusion Splicer Types

A fusion splicer is quite a spectacular splicing machine that helps to ease the fiber fusion splicing technique for connecting two pieces of optical fiber cables. In this process, two pieces of fiber wire

### Splicing Machine , Fiber Fusion Splicer , Fiber Optics

Fiber Fusion Splicers GAO's fiber fusion splicers are used in the field of fiber optics to join or splice two optical fibers together. Our product is an essential tool for creating a continuous and low-loss



### Z2C Fusion Splicer Overview , PDF , Optical Fiber

Z2C catalogue (INDIA) 205\*292 Z2C Core Alignment fusion splicer Z2C SumiCloud Useful cloud hosted splicer services via your smartphone App. Fast, Capable,

### 12 Core Single Mode Fiber Optic Cable

Shop high-quality 12 core single mode fiber optic cables for reliable communication. Enjoy durable,



efficient, and cost-effective solutions for your needs.



## Fiber Optic Fusion Splicers

Prepared fiber ends are placed in the splicer and automatically aligned and then fused together. This method ensures greater reliability with less light being scattered or reflected back by the splice.



### OFS-95EA FTTx Fusion Splicer , apex-optics

ShineWay OFS-95EA Fiber Optic Fusion Splicer is designed as a highly flexible instrument with 4-motor precision control and splice loss lower than 0.02dB for



## Fiber Optic Cable Splicing Explained

Fiber optic cable mechanical splicing is an alternate splicing technique that does not require a fusion splicer. A mechanical splice is a junction of two or



## Shineway OFS-95 Fiber Optic Fusion Splicer , Heynen

Designed as a highly flexible instrument with 6-motor precise micron level control and splice loss lower than 0.02dB for G.652 fiber. Equipped with removable



## Fiber Optic Tools

Fiber Optic Tools end Fiber Optic Test Equipment. Testing and monitoring, Splicing Tools and more shop now. Same day shipping.

## Fiber optic splicing box-AliExpress

When selecting a fiber optic splicing box, it's also important to consider related products such as fiber optic fusion box, fiber optic splice enclosure, fiber optic cable splicing, and fiber optic splicing tools.



## Fiber Fusion Splicing

Fiber splicing is essential for extending fiber optic networks, repairing damaged cables, and connecting optical fibers in various applications, including



Ordering information

NO.	1	2	3	4
Model	F4001	F4002	F4003	F4004
Product name	Patch Panel	Patch Panel	Patch Panel	Patch Panel
Illustration				
NO.	1	2	3	4
Maximum number of cores	96	192	288	384
Product size (including modules and drawers)	482.0*208.7*43.3mm	482.0*208.7*86.3mm	482.0*208.7*133.3mm	482.0*208.7*177.0mm
Standard color code	RAL9005	RAL9005	RAL9005	RAL9005

### splicing G657 with G652 fibers : r/FiberOptics

Under normal circumstances, joining two dissimilar fiber strands will always result in a loss because of the mismatched index of refraction. For example, if the left cable is made by AFL and the right cable

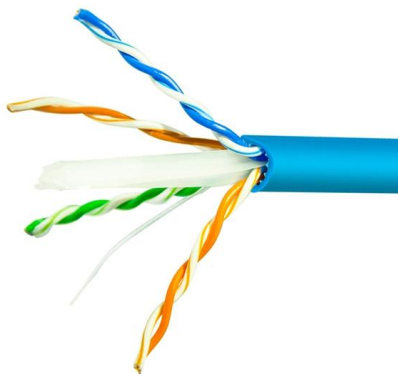

### Fusion Splicer

In today's high-speed digital world, reliable fiber optic networks are the backbone of global communication. Whether you're working in telecommunications, data centers, or military

### Fiber Optic Fusion Splicers , Fiber Splicing Machine Kit

Best fiber optic fusion splicer machines at fiberoptic.is. Featuring core alignment and automatic fusion splicers for precise telecom and network fiber splicing.





## Urgently Hiring Fiber Optic Project Manager Jobs in Oklahoma

Prep and splice single-mode (SM) and multi-mode (MM) optical fiber cables ranging from single to ribbon and loose tube. Splice and repair fiber optic cables using single and mass fusion equipment.

## Fiber Optic Splicer Entry Level Jobs May, 2026 (Hiring Now!)

1,060 Entry Level Fiber Optic Splicer jobs hiring near me. Apply to entry level Fiber Optic Splicer jobs with estimated salaries, company ratings, and highlights. Browse for entry level internships, junior

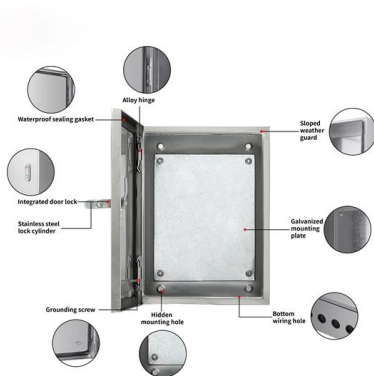
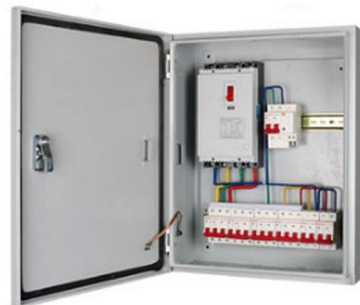

## The Ultimate Guide to Splicing of Fiber: Techniques and Tips

This technique ensures uninterrupted data transmission by seamlessly connecting two fibers. What are the main types of fiber optic splicing methods? There are two primary methods for

## G657 Fiber Splicing

Since its introduction, ITU-T G.657 optical fibre cables have seen a steady increase in the total optical fibre cable market. What is G657 fibre? G657 is a new class of

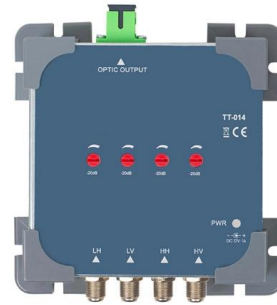

## Fusion Splicing: What's and How's Answered? , Versitron

There are two ways of fiber optic cable termination, namely, connectors and splicing. Out of which, splicing is chosen for connecting two bare

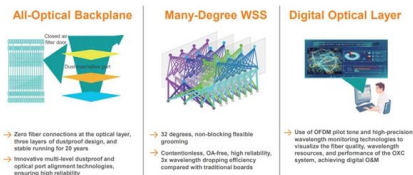

## Optical fiber fusion splicer configuration, connection method and

The optical fiber connection adopts the fusion splicing method. Welding is based on melting the inner hole of the optical fiber and connecting the two optical fibers together. The whole



## Mastering Optical Fiber

Introduction: The Critical Role of Fusion Splicing  
Fusion splicing is the bedrock of high-performance fiber optic networks, enabling seamless signal





## G.654.E Fibre Cable

Cabling: when installed according to best practices, fibre optic cables can last for more than 40 years, maintaining mechanical integrity and optical performance over decades.



## Fiber Optic Fusion Splicers , Fiber Splicing Machine Kit

A fusion splicer is a sophisticated device that permanently joins optical fibers end to end by melting their ends together and forming a complete optical path. This

## How to Splice Fiber Optic Cable - Step-by-Step Fusion

Learn how to splice fiber optic cable using fusion splicing with this complete step-by-step guide. Includes tools, best practices, loss standards (ITU-T

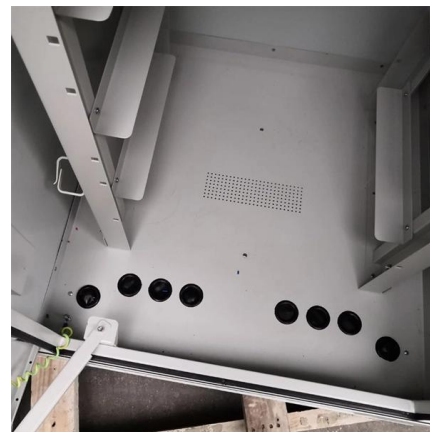

## A comprehensive tutorial on how to connect fiber optic

Understanding Fusion Splicer A fusion splicer is a specialized tool used in fiber optic networks to join two fiber optic cables together permanently. It



## Fusion Splicers , Telecommunication Systems Business

Fusion splicer enable splicing of Fiber Optic Cable with low loss and high reliability. For fusion splicer, we offer two types: Core alignment fusion splicer, which bring



## Fusion Splicing Guidance for Single-Mode Fibers A

Fusion Splicing 101 Fusion splicing permanently joins two optical fibers when no additional changes to those fibers are expected at that juncture. This is in contrast to connectors, which are designed to



## EPCOM's Premier Fiber Optic Distribution Box Choice

Fiber Optic Distribution Box ensures reliable FTTx, 5G, IoT connectivity. Learn types, parts, and selection for high-speed networks.





## Improvement in fusion performance between G652.D fiber and Ultra

Eventually, the proposed method has been directly applied to fiber optic splicing projects, improving the success rate and efficiency of on-site splicing fibers under adverse circumstances to a

## Top 5 Fusion Splicers for 2025: Precision Tools for Fiber

A fusion splicer is a precision tool used to join two optical fibers by fusing them together with an electric arc. This process minimizes signal loss and



## Ultimate Guide to Using a Fusion Splicer for Fiber Optic

Learn how to use a fusion splicer for fiber optic cable with our ultimate guide. We cover everything from the basics to advanced techniques with popular

## OFS-95S Core Alignment Fusion Splicer

OFS - 95S fiber optic fusion splicer is designed as a highly flexible instrument with 6 -motor precise micron level control and splice loss lower than 0.02dB for G.652 fiber.



### **Improvement in fusion performance between G652.D fiber and Ultra**

Optical fiber fusion joints are important components of large-span, relay-free and ultra-long fiber optic links, whose performance has always been affecting the normal operation of the entire

### **GAOTek FTTH Optical Fiber Fusion Splicer Equipment**

GAOTek FTTH optical fiber fusion splicers have fully automatic, mainline fiber optical fusion splicers with six motors and fiber core alignment, capable of welding long



### **Standard for Installing and Testing Fiber Optics**

Fiber optic cables installed without connectors may be terminated by field termination by installing connectors onto the fibers using different types of termination processes or by splicing preterminated



## What Is Fiber Optic Cable Splicing? A Beginner's Guide

What is fiber optic cable splicing? Fiber optic cable splicing involves joining two fiber optic cables together. Another method of connecting optical

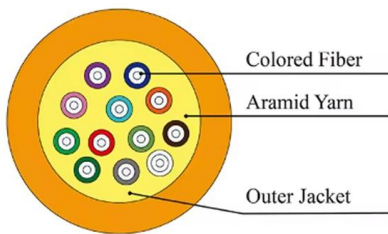

## Verified Supplier 12 Core Optical Fiber Cable 5k+ , Alibaba

A 12-core optical fiber cable contains twelve individual fiber strands, each capable of transmitting data over long distances using pulses of light. These cables are essential in modern telecommunications,

## How To Master Fusion Splicer For Fiber Optic Cables?

Fiber-optic cables are the backbone of modern communication systems, enabling rapid data transfer across vast distances. The efficiency and



## Contact Us

---

For datasheets, pricing, or custom telecom energy solutions, please visit:  
<https://www.koskolong.co.za>