

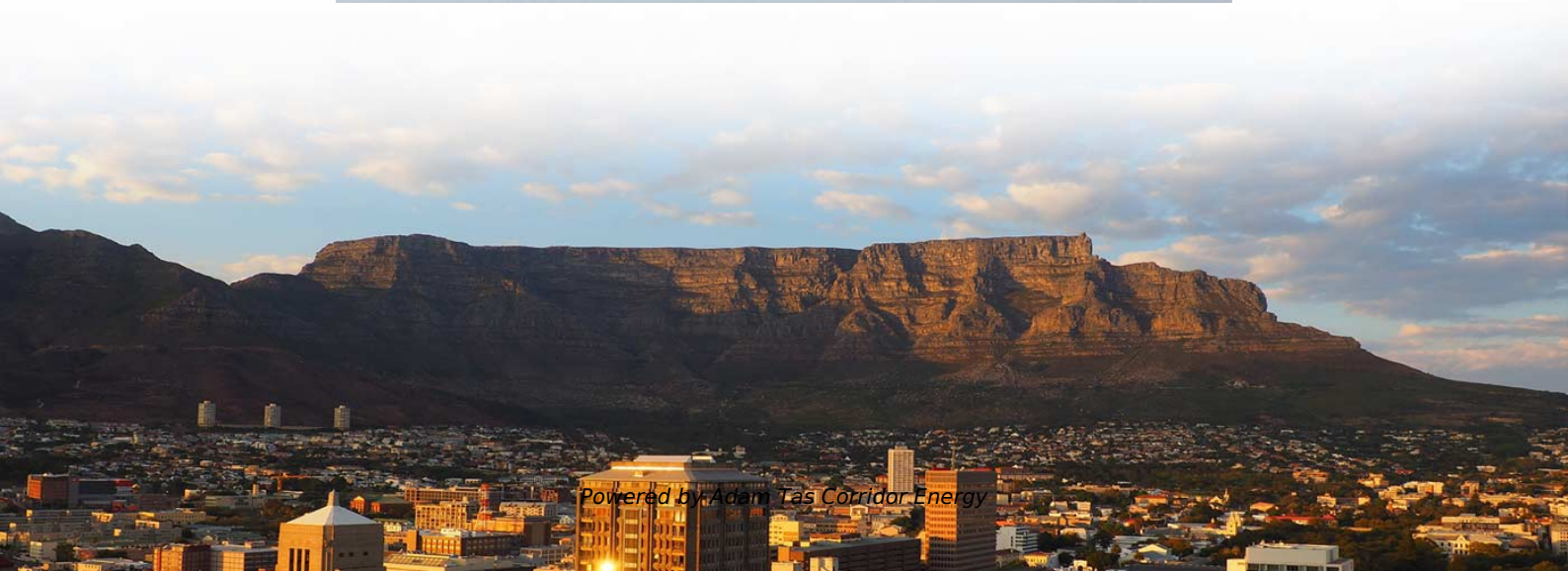

Adam Tas Corridor Energy

Huijue 24-port Metal Fiber Optic Terminal Box

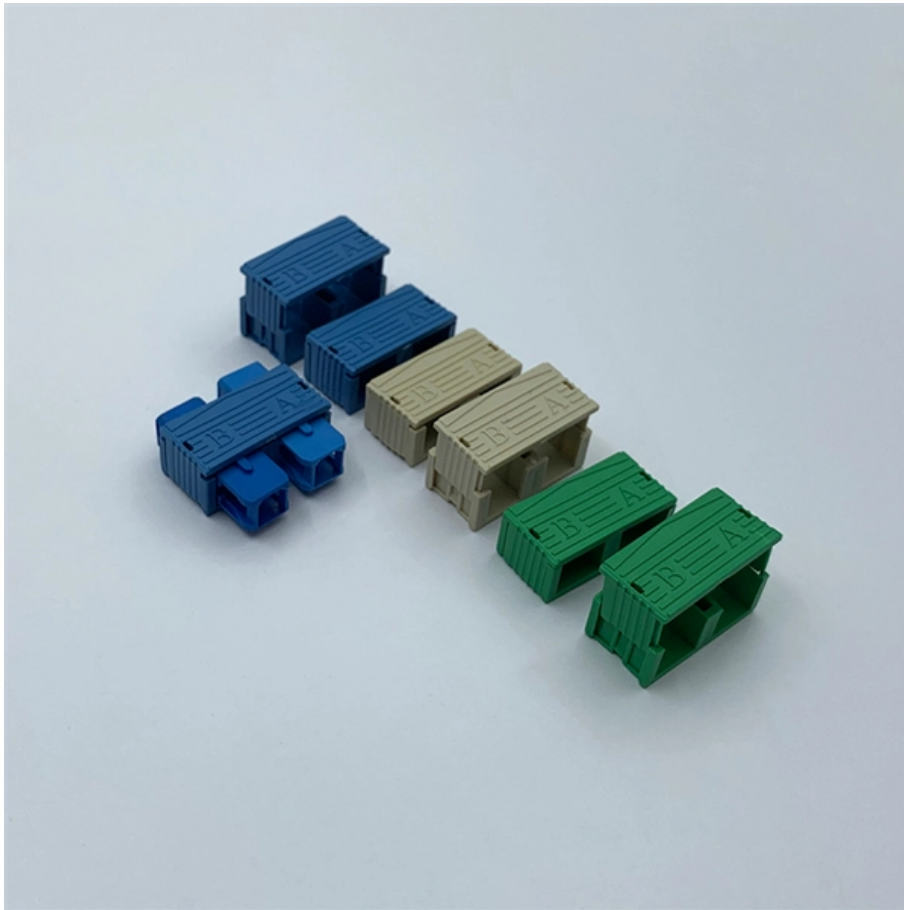



Huijue 24-port Metal Fiber Optic Terminal Box



12 Fibers Rack Mounted Fiber Optic Terminal Box As distribution box

Buy high quality 12 Cores Rack Mounted Fiber Optic Terminal Box As distribution box FS-JJ/SC24-12C cables management from China Fiber Termination Box supplier with free shipping to worldwide and

Fiber optic terminal box-Shenzhen Hiphotonics Optical

Hiphotonics's Fiber Optic Terminal Box is designed for efficient fiber termination, splicing, and distribution in FTTH, FTTX, and data communication networks. Compact and durable, our terminal

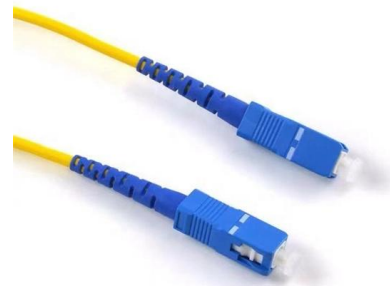

Fiber Terminal Box , Leading Network Server Cabinet, Integrated

Fiber Terminal Box Manufacturer More than 20 Years Experience At the heart of every fiber-to-fiber and fiber-to-device interconnect is a precision fiber optic interconnect assembly. Huijue is committed

Fiber Termination Box Manufacturer , FTTH FTTx Solutions

Spring Optical provides fiber termination boxes with 2-48 ports, including outdoor IP65/IP66, NID,



NAP, and wall-mounted solutions for FTTH and FTTx networks.



24 port Fiber Distribution Box

Suited for FTTH engineering cables reaching buildings, it can be installed in corridors, basements, computer rooms and exterior walls. It enables fiber



Durable FTTH Terminal Box , Fiber Termination

Explore reliable FTTH terminal boxes for secure fiber termination and distribution. Wall-mounted design, robust build, for home and industrial optical networks.

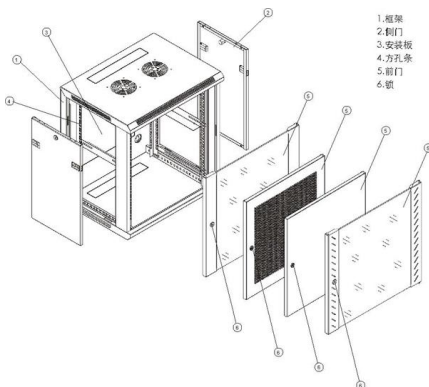

24 ports fiber optic terminal box

Fiber optic terminal box is available for the distribution and terminal connection of various kinds of optical fiber system, especially suitable for mini-network terminal



Fiber Terminal Box , Leading Network Server Cabinet, Integrated

As a leading Fiber Terminal Box Manufacturer manufacturer and supplier, Huijue has been providing customers with the best and most suitable products and solutions. Our headquartered in Shanghai, it



Fiber Optic 24Core Termination Box with adaptors

Besides, we have a mass production factory of 50, 000 square meters in Jiangsu province, which is mainly for metal precise production, assembly of cabinets and optical fiber products.

FTB-ABS-12/16/24, Fiber Termination Box up to 24 ports

Fiber Identifiers Fault Locators Fiber Monitoring
Fiber Optic Sensors Light Sources MPO Test
Equipment OTDR & Software



Component Diagram

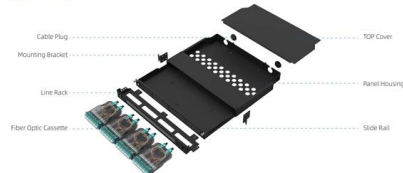

Key dimensions

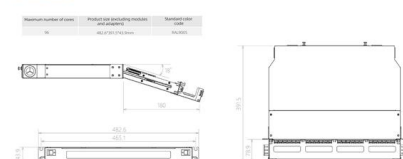

24 Port Fiber Optic Terminal Box

Structural features All property indexes are in accordance with National YD/T814-1996 Standard. The body makes use of cold rolling steel, and the surface use the technique of dim blowing plastic.



Fiber Optic Terminal Box 24 core FAT-24C

Description FAT-24C Fiber Termination Box provides a high density wall mounted solution for next generation networks, which aims to provide and manage



fiber optic terminal box

The 24 SC Fiber Optic Terminal Box Fixed Type is an efficient solution designed for managing and protecting fiber connections.

Fiber Optic 24 Port FTTH Terminal Box/Distribution Box

Fiber Optic 24 Port FTTH Terminal Box/Distribution Box The equipment is used as a termination point for the feeder cable to connect with drop cable in FTTH



24 port SC terminal box fiber optic cable 24 port SC

Electrical Boxes Conduit Fittings: Which can be cleaned and wiped with a damp cloth, protecting the optical fiber from damage, and extend the service life of



PTE 24 U.I. 24-Port Fiber Optic Terminal Box Manufacturer

The 24-Port Fiber Optic Terminal Box presents all connections in one unified high-density rack of 24 SC/APC adapters without flanges. The innovative sliding



24 Core Fiber Optic Termination Box/ Junction Box

Product Description FTKS-1805-16F 24 core Fiber Optic Termination Box/ Junction box 1. Product Description This box is used as a termination point for the feeder

24 core SC24 Type Fiber Terminal Box As distribution box

The Fiber Optic Terminal Box is a kind of optical fiber management products used to distribute and protect the optical fiber links in FTTH Network. It is available for the distribution and terminal





Indoor/Outdoor 24-port Plastic Fiber Terminal Box

This plastic indoor/outdoor fiber optic terminal box has a latching top for easy access and accepts up to 24 fiber optic panel mount couplers. It is used to interconnect

Premium-Line 24 ports Wall Mounted Fiber Optic Box

Premium Line 24 ports wall mount fiber optic box is used for the direct termination of fibers. Box include two separate sections.



Fiber Termination Box: 8-96 Cores, IP65/IP68 Protection

Discover Fiber Termination Box, supporting 8-96 cores with IP65/IP68 protection for durable and versatile installations. Order now for unmatched reliability!

Fiber Optic Terminal Box 24 core FAT-24B

Description FAT-24B Fiber Termination Box provides a high density wall mounted solution for next generation networks. It provides and manages 24 fibers at

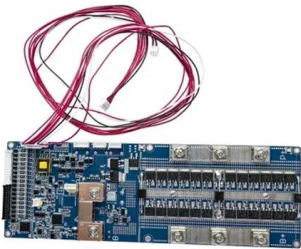
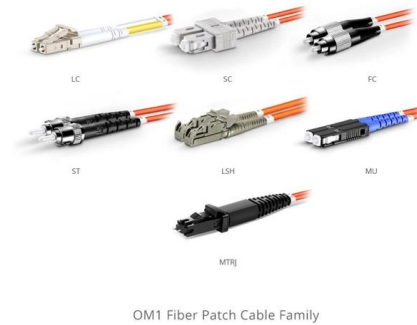

Outdoor 24 port optical network terminal box

Telhua's outdoor 24-port optical network terminal box delivers high-density fiber termination with IP68 protection. Engineered for reliability in extreme

Fiber Terminal Box, 24* Port Optical Fiber Distribution Hub

This Fiber Terminal box is for indoor/outdoor application, with 24 fiber termination capacity (48 fiber for LC connectors). It is usually located in the user access point,



Fiber Terminal Box, 24* Port Optical Fiber Distribution Hub

In FTTx-ODN network this fiber terminal box can be used with optical splitters, while achieving spectral functions. Widely used in "Fiber To The Home" access





24F Terminal Access Box - PPC Broadband , Product Catalog

This terminal is small, light-weight and perfect for fiber routing. It's wall mountable, and easy to install and maintain. The terminal access box provides 8, 16 or 24 ports in a simple, single-layer design -

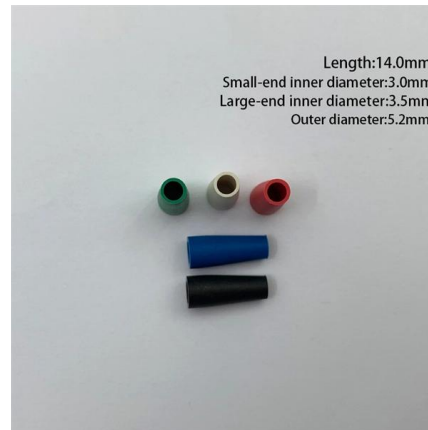

HJ Outdoor Fiber Optic Terminal Box Metal Wall Mount Waterproof

Material Cold-rolled Steel (SPCC), Aluminum Alloy
Sheet Metal Thickness 1.0mm, 1.2mm, 1.5mm
Cable Entry Ports 2 Ports, 4 Ports (Back/Side)
Diameter 20mm, 25mm Splice Tray Specification
12

24 Cores Fiber Optic Junction Box/Terminal Box with

Product Description FTKS-1805-24A1 24 Cores
Fiber Optic Junction Box/Terminal Box with pigtail
and connector inside 1.Product Description The
equipment is



Contact Us

For datasheets, pricing, or custom telecom energy solutions, please visit:
<https://www.koskolong.co.za>