

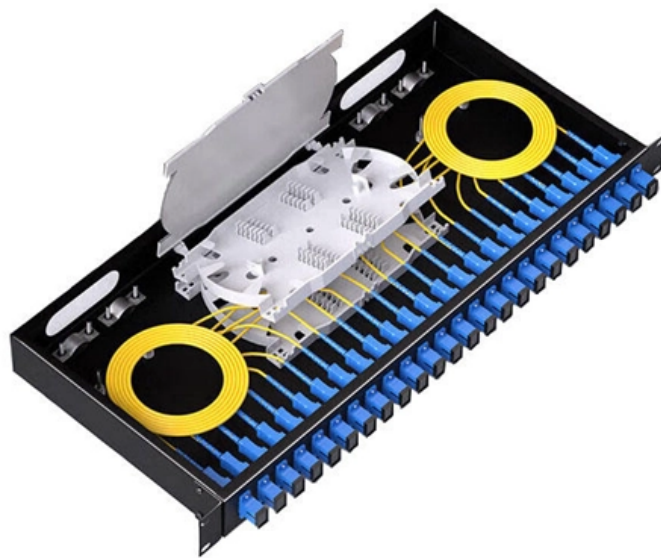

Adam Tas Corridor Energy

Installation of Home Intelligent Distribution Box System





Installation of Home Intelligent Distribution Box System

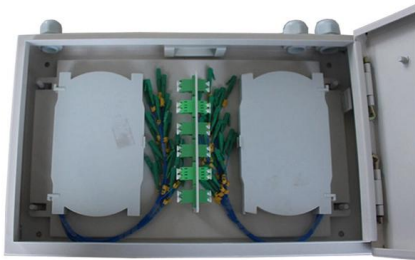

How to create an intelligent distribution architecture with

They can speed up the design of their projects leveraging ABB standardized and flexible intelligent distribution solutions. Thanks to the cooperation with EPLAN,

Intelligent Distribution Solution , Huawei Enterprise

Huawei's Intelligent Power Distribution Solution contributes to the implementation of transparent sensing of power distribution transformer districts and the enhancement of intelligent service capabilities,

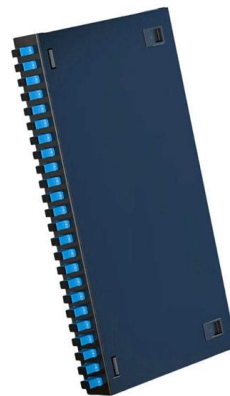

Intelligent Distribution , Solutions , ABB

Our solutions for smart low voltage electrical installations are tailored to maximize continuity of service, energy efficiency and allow easy upgrades all along the

Intelligent Power Distribution Box Solution - Smart Home

It is mainly composed of the center control



system with KC868-H8 device, the AC contactor with manual control and the air switch. The concrete structure diagram is as follows:



Electrical Distribution Boxes for Power Distribution

Unlike conventional installation, you can lay the lines first and install the distribution box at a later time. The robust sheet steel housing protects the sensitive



How to Install a Cable Distribution Box Safely and

Reliable cable distribution boxes ensure safe, efficient power management for residential, commercial, and industrial systems. Learn



Design and Construction of a 60a Smart Distribution Board with Real

To design a 60A smart distribution board with real-time monitoring capabilities, enabling users to track electrical consumption and system performance remotely. To develop an intelligent load





Cost-Effective Design of IoT-Based Smart Household Distribution System

Abstract: The Internet of Things (IoT) plays an indispensable role in present-day household electricity management. Nevertheless, practical development of cost-effective intelligent condition monitoring,



Design and Construction of a 60a Smart Distribution Board with Real

Professional Installation: Installation should be carried out by qualified electricians who understand the intricacies of smart systems and can guarantee a safe and functional setup.

Power Distribution Boxes Explained Simply

In homes, distribution boxes are used to manage everyday power needs. They control electricity for kitchen appliances, lighting, HVAC systems,

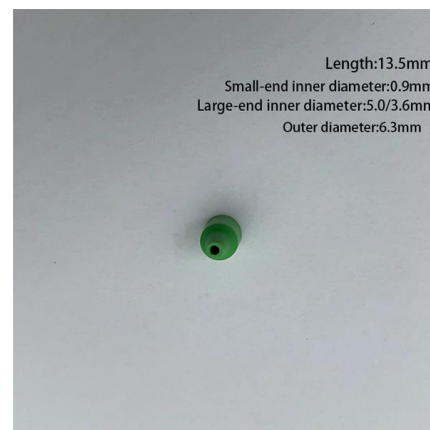

WO2024255014A1

The intelligent distribution box comprises multiple electrical devices, the electrical devices at least comprising a common power supply module, a main input intelligent circuit breaker, at least one

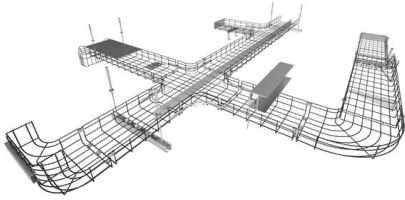

ITPro Today, Network Computing, IoT World Today combine

ITPro Today, Network Computing and IoT World Today have combined with TechTarget . The page you are looking for may no longer exist.



[Smart Home Automation DIY] Make 1 and 3 phase Power Distribution Box

Here is the Ultimate Smart Home Tech Tour for Distribution Board DIY used by KC868 Smart Controller. Step by step, it's very easy to DIY. Perfect for Smart home 2020.

Building a Smart Distribution Panel: The Ultimate DIY Project

We'll explore the components, functionality, and step-by-step process of building your own intelligent power control system, empowering you to take charge of your electrical infrastructure like





Home Automation Project DIY Smart Home Tech IOT Power Distribution Box

Everyone can modify and change the code for your own smart home automation system project. it support use by ESPHome for home assistant or tasmota firmware for smart home automation DIY.

How to Choose a House Distribution Box , CHINT global

A well-chosen distribution box ensures the safety and efficiency of your household electrical system. This article guides you through selecting a



Distribution box

Whether in your own home, in a rented apartment or in a business, the distribution box is a central element of every electrical system. Despite this, it often ekes out an inconspicuous existence in the

DISTRIBUTION BOX SMART INSTALLATION

Our distribution boxes serve as a link between automation and field level and thus form the interface for decentralized pluggable electrical installation.

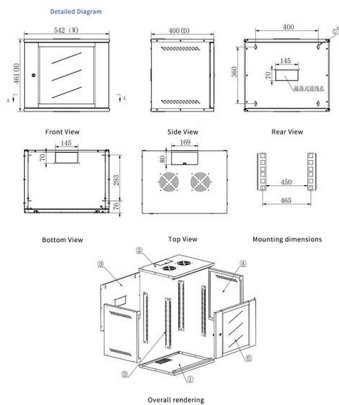

Design of a Smart Distribution Panelboard Using IoT

The main purpose of this work is to realize a low-voltage electrical distribution panelboard that allows for real-time load monitoring and that provides

Size determination, installation method and wiring mode

The distribution box is the central hub of the home circuit and the general control of our daily power consumption. It is an indispensable electrical equipment. If there



Electric Panel Installation Method Statement

METHOD STATEMENT FOR Electric panel and distribution box installation and termination - Free download as PDF File (.pdf), Text File (.txt) or read online for





Room Automation Distribution Boxes for DALI & Building

Intelligent room automation devices are essential to ensure that they perform their task ideally. For fast, flexible and safe installation, we integrate the devices into



How to Install a Distribution Box--A Comprehensive

Whether you are an electrical contractor or a construction brigade, knowing how to properly and safely install distribution boxes is the basis of

Understanding Distribution Boxes: A Comprehensive Guide

support safer operation in electrical systems For this reason, distribution boxes are widely used in homes, commercial buildings, industrial

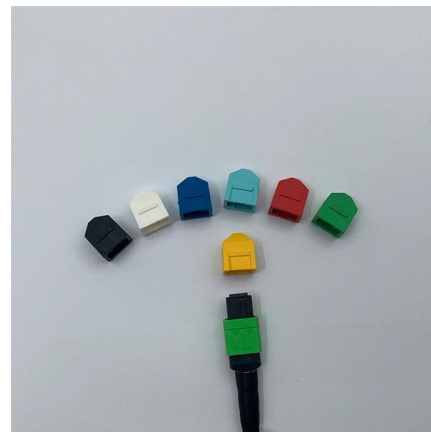

Design of a Smart Distribution Panelboard Using IoT

Electric load management through continuous monitoring and intelligent controlling has become a pressing requirement, particularly in light of



Contact Us

For datasheets, pricing, or custom telecom energy solutions, please visit:
<https://www.koskolong.co.za>