

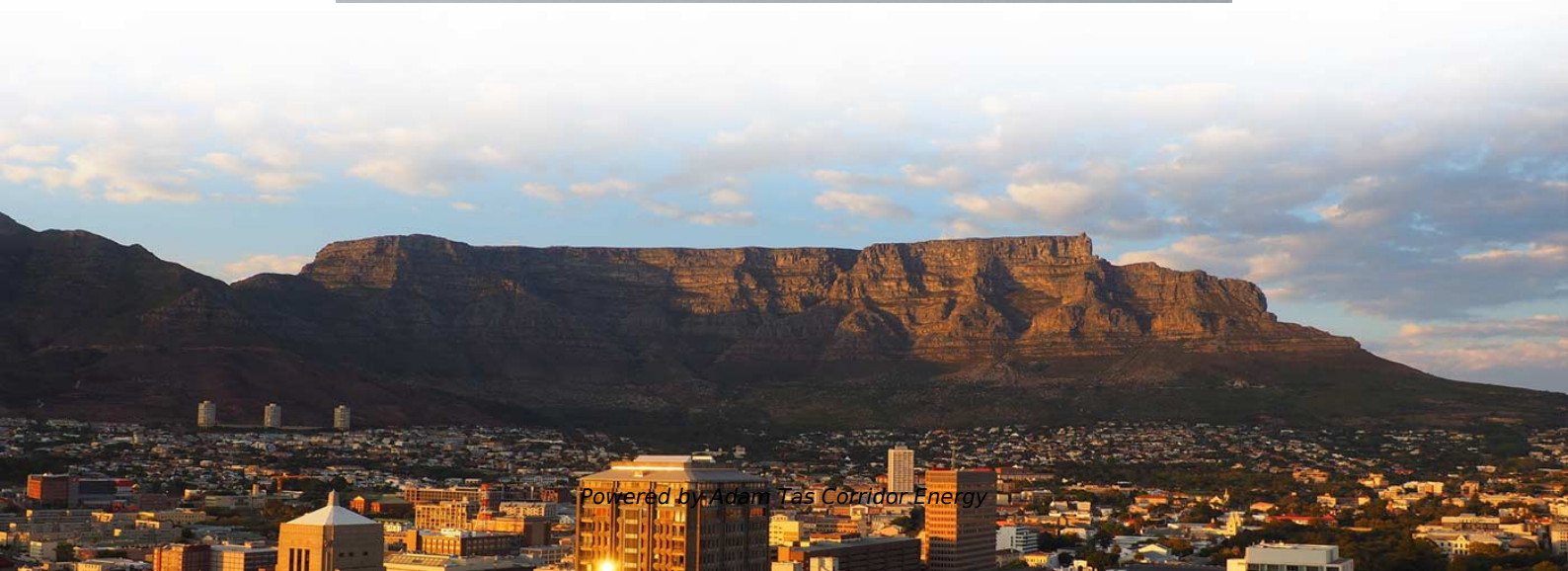

**Adam Tas Corridor Energy**

# **LC type 24-port fiber optic patch panel**

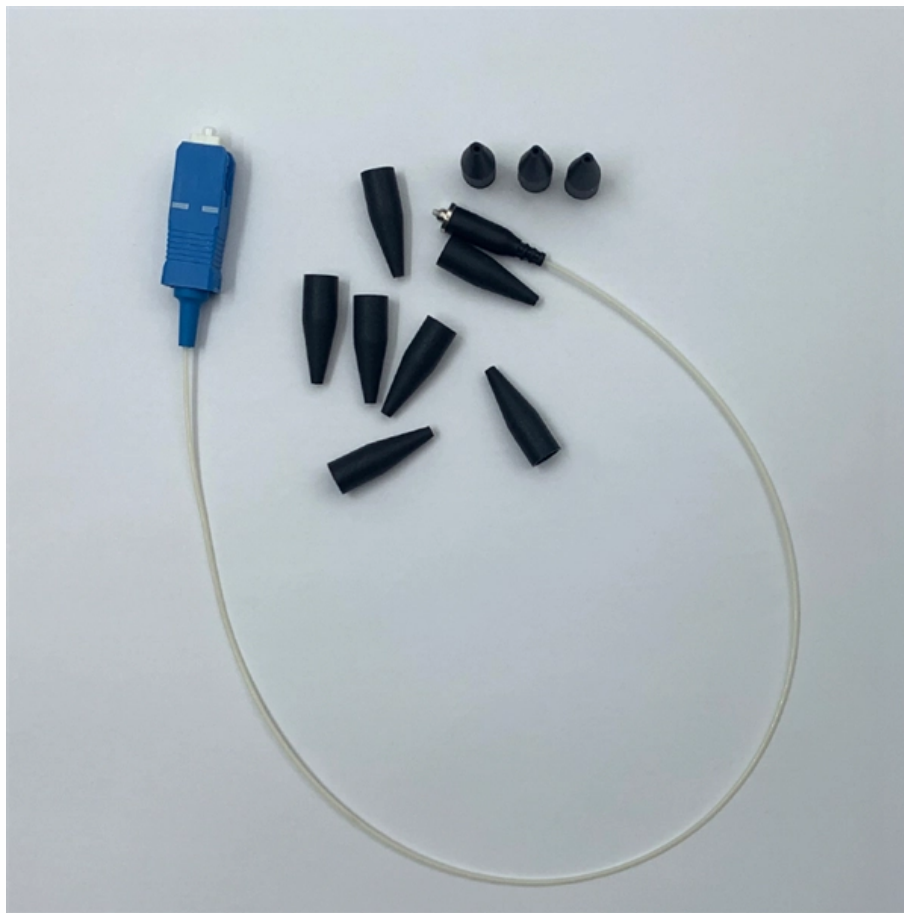



## LC type 24-port fiber optic patch panel

---

### More durable and robust

The outer layer is made of environmentally friendly PVC, which is soft and elastic. It can be stretched without damage, so you can use it with confidence.



### 8 Port Wall Mount Fiber Optic Patch Panel

Description The 8 Port Fiber Patch Panel is a compact wall mount enclosure designed for indoor fiber optic distribution. It supports up to 8 adapter ports,

### Rackmount Fiber Patch Panels

Our Preloaded Patch Panels are a very affordable option for organizing fiber optic networks. Available in Single and Multi-mode options, these loaded Fiber Distribution boxes come in 12, 24, 36, 48, 72 96



### Fiber Optic Cables , Fiber Patch Cables , Patch Cords,

Fiber Patch Cables, Multimode & Singlemode Duplex Fiber Optic Cables, Secure Order Fiber Patch Cords, Preferred Mil. Edu. Gov. Pricing, Same Day Shipping

### RS PRO 24 Port LC, Duplex Fibre Optic Patch Panel With 24 Ports

This RS PRO LC (lucent connector) multimode fibre optic patch panel has 24 populated ports



and serves to order and separate fibre optic wires. Use it to relay data signals, terminate your fibre optic



### Fiber Optic Patch Panel Guide

A fiber optic patch panel serves as a centralized, passive hardware enclosure that organizes, terminates, and protects fiber optic cables. It provides a static interface between structural

### Fiber Optic Patch Panels Types Prices & Technical

A standard 1U patch panel typically holds up to 24 SC ports or 48 LC ports. For higher counts like 96 or 144 fibers, you would move to a 2U, 3U, or 4U fiber

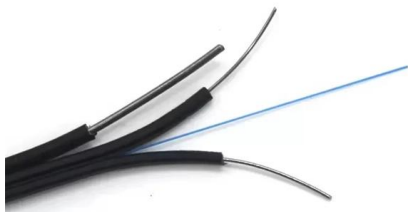

### 1U 24 Ports SC SX/LC DX Sliding Patch Panel

Nexconec sliding patch panel accepts 24 adapters SC Simplex or LC Duplex within 1U space. The panel can be pre-loaded completely with the required adapters or



## Patch Panels: A Complete Guide

There are also patch panels designed with fiber optics in mind. These can support a range of optical fiber connectors, including lucent connector (LC),

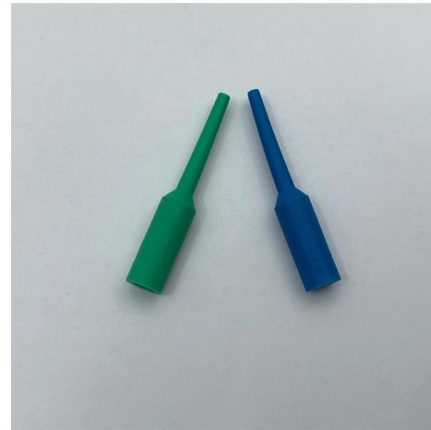

## SC vs LC Patch Cords: Key Differences & Uses

Fiber optic patch cords are short-length cables (typically 1-10 meters) with connectors on both ends, used to link network devices like switches, routers, transceivers, and ODFs (Optical

## LF1SLD24B

Product Overview Suitable Applications: Fiber Express solution for Backbone, Telecommunication Room, Main Distribution room and Data centers



## AOC, DAC, Fiber Optic Transceivers , One-Stop Shop

Online shopping. w/24h-delivery, 7Days & Refund Guarantee. CE, RoHS and ISO9001 Certified. SFP+ Cables, QSFP+ Cables, MiniSAS Cables, XFP Cables,



### 12 Port Sliding Fiber Patch Panel For SC LC Option-

This rack mount 12 port fiber patch panel supports LC and SC adapters, suitable for rack in FTTH and data center applications.

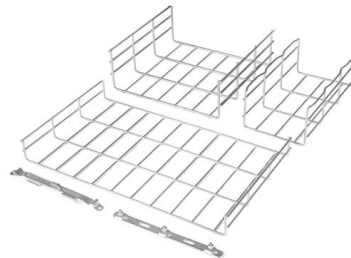

### Fiber Optic Patch Panels and Enclosures

Fiber Optic Patch Panels comprise of various products that can support the optical fibers termination or fusion splicing works. They are usually deployed to store

### Optical Distribution Frames (ODF)

Fiber cable termination unit (1) Fiber cabled module (77) Fiber module (62) Fiber optic terminal jumper storage panel (1) Fiber patch block (71) Fiber patch block, with IFC cable (14) Fiber patch cabinet





## 2U 19 Inch Fiber Optic Patch Panel 24 48 72 96 Port ODF Rack

Connector Type SC, LC, FC, ST Use FTTH, FTTB, FTTX, Data Center Model Number Fiber Patch Panel Brand Name YOFC Place of Origin Hubei, China Warranty Time 1 Frequency Range 1310nm /

## GESD 4PCS 6 Duplex 12 Core LC Adapters OM3 Fiber Patch Panel

Key Features 4PCS LGX Footprint OM3 Fiber Patch Panel Loaded with 6 Duplex LC 12 Fiber Ports Adapters, Streamlines Fiber Optic Cable Patching Ceramic Inserts, Constructed in High Quality Steel



## 12 Port LC Fiber Patch Panel

Choice of 12 or 24 cores fibre patch panel for multimode and single mode fibre cable. You can order this 12 port LC fiber patch panel ODFKLC12 with LC duplex single

## 12-Port LC Fiber Patch Panel for sale & price in Ethiopia

12-Port LC Fiber Patch Panel for sale & price in Ethiopia Price : 18,000.00 ETB Posted 2 months ago Brand CISCO Condition New Description Type: Rack

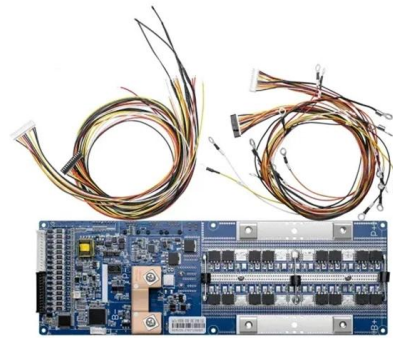

## Fiber Optic Cables, Patch Panels & Networking Products

Shop high-quality fiber optic cables, patch panels, adapters & networking solutions. Fast US shipping, bulk pricing, and reliable performance.

### 1U 24 port fiber patch panel for SC/LC/ST/FC Options -

Sliding 1U 24 ports SC LC fiber patch panel provides efficient and easy management of fiber optic cables in 19" or 23" framework.



### Optical fiber connector

An optical fiber connector is a device used to link optical fibers, facilitating the efficient transmission of light signals. An optical fiber connector enables quicker





## 24 Port LC Fiber Patch Panel

24 Port LC fiber patch panel provides high density flexible system

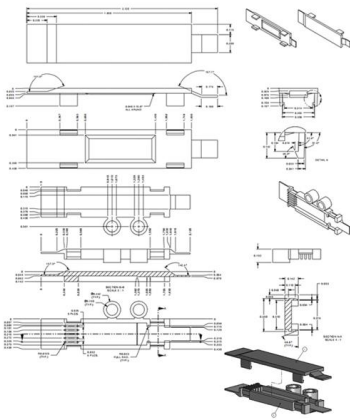

## DIN Rail Fiber Optic Patch Panel DPPY24 LC Duplex

DPPY24 BK Series LC Duplex DIN Rail Fiber Patch Panel provides secure

## kenable Fibre Optic Patch Panel 24 port with 12 x LC Duplex MM

1U 19 inch 24 Port Fibre Patch Panel loaded with 12 x Duplex LC MultiMode Glands (up to 24 Fibres) The panel features fully adjustable mounting brackets numbered adaptor ports and a range of panel



## 24 Port Fiber Optic Patch Panel LC Duplex Loaded

Shop 24 port fiber optic patch panel loaded with LC duplex adapters. Ideal for rack mount installations, data centers, and structured cabling systems.



### **Fiber Optic Distribution Frame (ODF) , Rack & Wall Mount**

Fiber optic distribution frame (ODF), also known as fiber patch panel or optical distribution frame, is a rack-mount or wall-mount enclosure that provides organized termination, splicing, and patching of



### **LC Fibre Patch Panel , Fibre Optic Patch Panels**

Recessed LC Fibre Optic Patch Panel, 1U 19" Rack mount, 24 port with no adaptors and rear cable management. Up to 48-way capacity (LC) with dual bulkhead coupler.



### **24 Port Fiber Optic Patch Panel 1U Multimode 24F MTP**

Configured for Polarity A and designed for implementations in 40G/100G networks, this fiber optic patch panel is designed for Data Centers, Telecommunication and

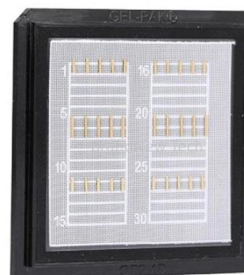



## **24 Port LC Fibre Patch Panel, OS2 Single Mode**

Panels can be directly mounted to 19" racks, assuring easy installation and flexible deployment. Additionally, the panel design provides easy access to the front and rear cables for cable

## **Contact Us**

---

For datasheets, pricing, or custom telecom energy solutions, please visit:  
<https://www.koskolong.co.za>