

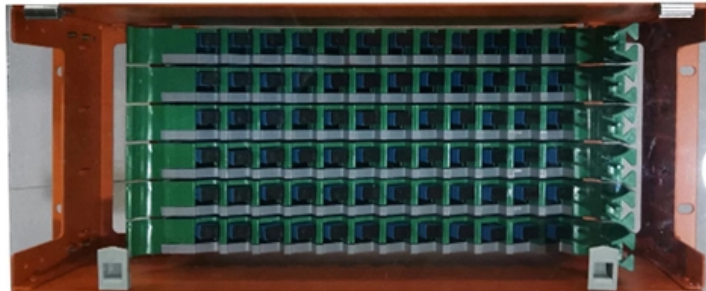

Adam Tas Corridor Energy

New Zealand Cross-Border Optical Cable





Overview

A cable that roughly doubles New Zealand's internet connectivity to the rest of the world is now in service. The US\$350 million (\$570m) SX Next cable runs between Auckland, Sydney and Los Angeles and will also provide the first fibre-optic broadband connections to Tokelau and. The country is served by several key undersea cables including the Southern Cross Cable, Hawaiki Cable, and the Southern Cross NEXT. The Pacific Fibre cable is a new 12,750km (7,920 miles) trans-pacific subsea fiber optic cable linking Australia, New Zealand and the US, with cable landing stations in Sydney, Auckland and Los Angeles.



New Zealand Cross-Border Optical Cable

Vodafone NZ upgrades international submarine network technology



This means Vodafone NZ is now the only operator in New Zealand offering exclusive-use optical capacity across all three international fibre optic cables - Tasman Global Access (TGA),

Submarine Cables

Submarine Cables Installation, monitoring and maintenance of submarine cable systems. Seaworks has a long and successful record of installing, monitoring and maintaining submarine cable systems for

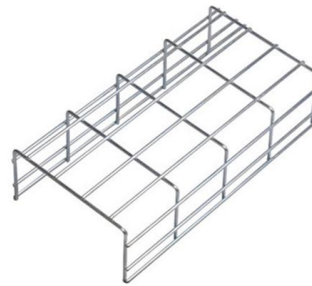

New Zealand Traveller Declaration

New Zealand Traveller Declaration
Whakapuakanga Tangata Haere ki Aotearoa The New Zealand Traveller Declaration (NZTD) system collects your travel, customs,

Southern Cross NEXT Cable System Overview

Southern Cross NEXT is a private fiber-optic submarine cable network connecting Australia,



New Zealand, Fiji, Samoa, Tokelau, Kiribati, and the United

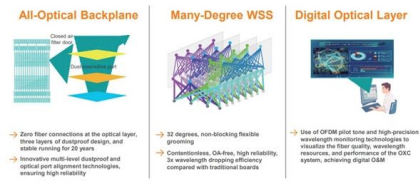

The Operation of Cross-Border Terrestrial Fibre-Optic Networks

Many cross-border terrestrial fibre-optic cable systems have been established between neighbouring countries through bilateral agreements. Yet, this regional network of terrestrial cables is not



New fiber-optic cable for Tokelau means reliable internet

The fibre optic cable In his address, President of Southern Cross NEXT, Laurie Miller, said this was a historic event for Southern Cross as well, since this was the first time New Zealand had

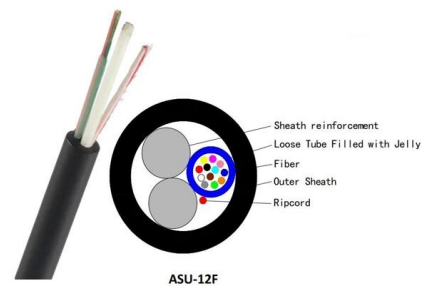

Subsea cable doubles NZ's internet capacity and offers reduced lag

A cable that roughly doubles New Zealand's internet connectivity to the rest of the world is now in service.





The operation of cross-border terrestrial fibre-optic

Many cross-border terrestrial fibre-optic cable systems have been established between neighbouring countries through bilateral agreements. Yet,



Southern Cross Next cable goes live, doubling NZ's

Photo / Chris Keall The Southern Cross Next cable linking New Zealand, Australia, and the US has gone live, nearly doubling NZ's global broadband connectivity.

The Cables That Keep New Zealand Connected To The World

Those glass fibres, contained in four submarine cables connecting New Zealand to the United States and Australia, carry virtually all communications to and from the country.



Launch Of New Submarine Cable Expands New Zealand's

Southern Cross Cables Limited ("SX") today announced the launch of its Southern Cross NEXT fibre cable (SX NEXT), creating the largest submarine network connecting Australasia to the



SX Next Takapuna

A recently installed submarine fibre optic cable that connects Auckland's Maraetai Beach to Waiheke Island has delivered two important benefits for the island's 10,000 residents. If you ever take the ferry



Wiley Online Library , Scientific research articles, journals, books

Hier sollte eine Beschreibung angezeigt werden, diese Seite lässt dies jedoch nicht zu.

Kaggle

" 'new',n", " 'sea',n", " 'hunt',n", " 'need',n", " 'change',n", " 'pace',n", " 'tv',n", " 'would',n", " 'work',n", " 'world',n", " 'water',n", " 'adventure',n", " 'oh',n", " 'way',n", " 'thank',n", " 'outlet',n",



Vodafone NZ upgrades international submarine network technology

"This rebuild of our international optical network offers a step-change in how we can manage internet traffic, connecting all three major submarine cables linking New Zealand with



Assessing the Risks and Vulnerability of New Zealand's

New Zealand, situated in a remote part of the globe, depends heavily on these fibre optic cables for international communication and internet access.



Explore stories across the world , Lonely Planet

Go with a plan. Come back with a story. Discover iconic recommendations, insights and experiences curated by Lonely Planet contributors.

Equinix and Southern Cross Cables to link internet in

Equinix and Southern Cross Cables will link the internet in New Zealand and Australia with the U.S. to boost network capacity by five-fold.





LED DISPLAY PANEL

CURRENT STATUS CLEARLY VISIBLE

IT CAN CLEARLY SHOW THE CURRENT STATUS AND VOLTAGE STATUS, WITH EFFICIENT OPERATION AND RAPID RESPONSE.

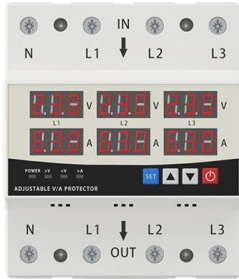

New Southern Cross Next international broadband cable

The Southern Cross Next cable, which will nearly double New Zealand's international broadband internet capacity, nearly made a landing at Auckland's Takapuna

Assessing the Risks and Vulnerability of New Zealand's

In 2024, the world's increasing reliance on digital connectivity has brought to the forefront the critical issue of the security of undersea cables. New



Geographical Service Coverage , FlexWave , Products

Currently, FlexWave is available in twenty-nine cities across New Zealand. FlexWave can also provide connectivity between an end point in Auckland New Zealand

Pacific Fibre

The Pacific Fibre cable is a new 12,750km (7,920 miles) trans-pacific subsea fiber optic cable linking Australia, New Zealand and the US, with cable landing stations in Sydney, Auckland and Los Angeles.

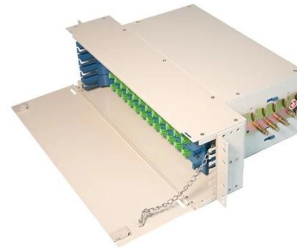

Southern Cross to build new Tasman Express subsea

The Tasman Express, a new subsea data circuit, is in the works for New Zealand after Southern Cross Cable signed contracts with French state

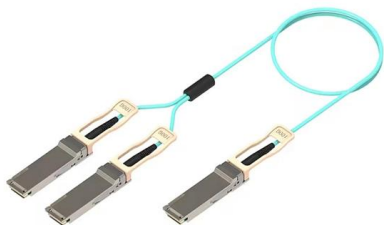

Geographical Service Coverage , FlexWave , Products

International Coverage FlexWave can also provide connectivity between an end point in Auckland New Zealand and a selected POP end point in Australia or USA

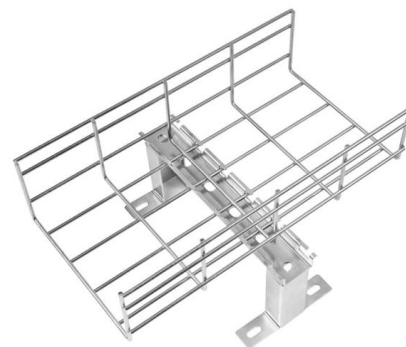

Launch Of New Submarine Cable Expands New Zealand

Southern Cross Cables Limited (SX) today announced the launch of its Southern Cross NEXT fibre cable (SX NEXT), creating the largest submarine network connecting Australasia to the





New submarine cable nearly doubles NZ's international connectivity

The Southern Cross NEXT fibre cable (SX NEXT), delivered by Alcatel Submarine Networks, created the largest submarine network connecting New Zealand, Australasia to the US,



NCP

The New Cross Pacific Cable System is a new generation high capacity fibre-optic submarine cable system across the Pacific Ocean directly connecting the US and Asia with landings in China,

The Single Object: The internet cable that connects us

In 2018 I installed a multi-platform installation, The Southern Cross Cable: A Tour, at City Gallery Wellington as part of the exhibition This Is New Zealand (2 March-29



SX NEXT Cable Launch , Spark Wholesale

The 15,840km SX NEXT cable, running from Sydney to Los Angeles with links to Auckland, Fiji, Tokelau, and Kiribati, becomes the third route in the Southern



Contact Us

For datasheets, pricing, or custom telecom energy solutions, please visit:
<https://www.koskolong.co.za>