

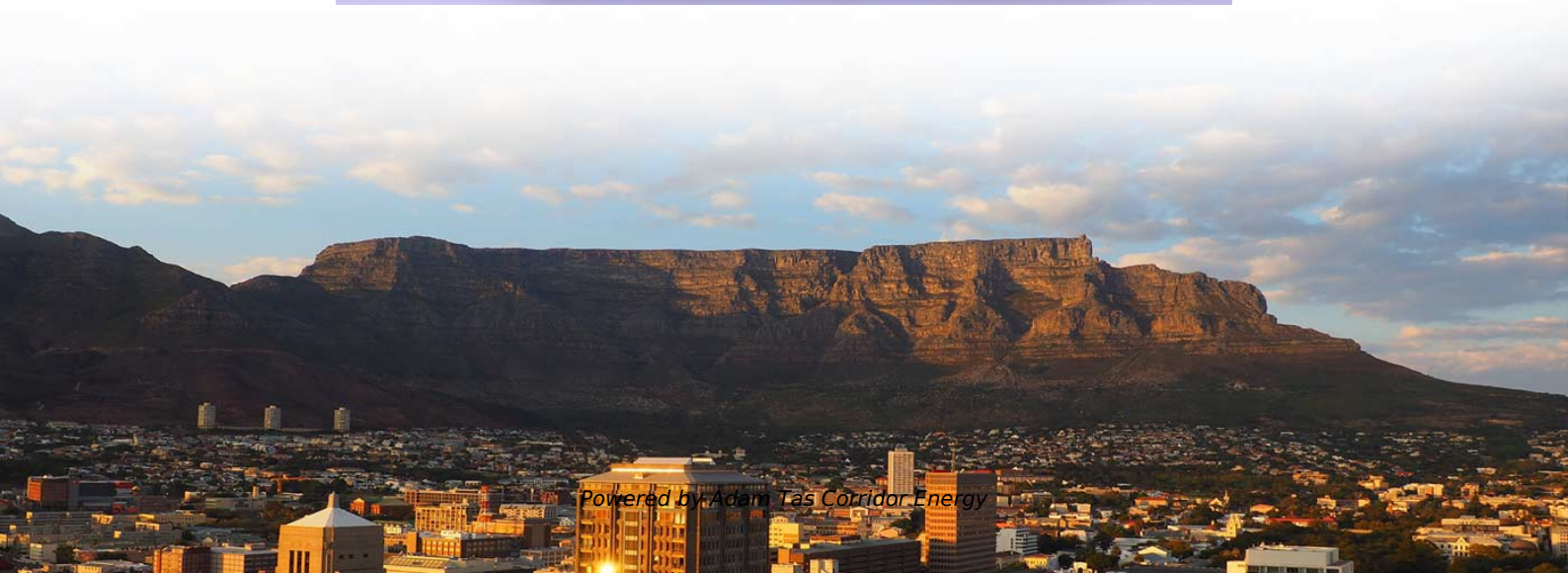

Adam Tas Corridor Energy

Price list for high-voltage enclosed busbars in Libya





Price list for high-voltage enclosed busbars in Libya



Busbar system

Find your busbar system easily amongst the 13 products from the leading brands (RITTAL, Kinto Electric, Giovenzana,) on DirectIndustry, the industry specialist

High-voltage busbar

Find your high-voltage busbar easily amongst the 6 products from the leading brands (LEONI, TELEDYNE, HLC,) on DirectIndustry, the industry specialist for your



REINFORCED VIRGIN PVC TRUNKING

Superior Crush Resistance



37.6MPA
Tensile Strength



2856MPA
Elastic Modulus



9.8KJ/M²
Impact Strength



1.54G/CM
Density

High voltage bus bar

These busbars are used in demanding environments, particularly in the healthcare and automotive industries, where high quality, reliability, and performance are

Busbar Products Pricing Guide: Understanding Costs

This guide offers a detailed busbar pricing guide for electrical contractors, explores what affects



pricing, and provides strategies to get the best value busbar

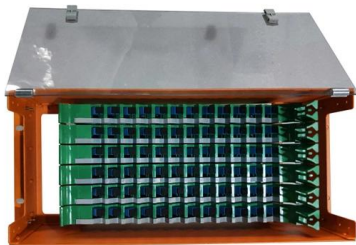

High Voltage Busbars by Intercable Automotive Solutions

High volume busbar production: employing craft precision. One of the signature products developed by Intercable Automotive Solutions are our custom made

Low-voltage busbars, price, to buy a busduct in Moscow,

Inexpensive busbars! «Russian Busbar Center» offers high quality Russian-made busducts. These products have shown good results at industrial facilities in RF, CIS and abroad.

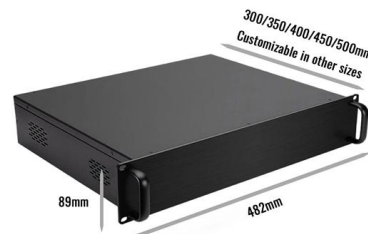

Elsewedy Electric Busway Overview , PDF , Electrical

The document provides information on Elsewedy Electric's busway factory and busway products. The factory is located in Egypt and aims to be one of the



METAL ENCLOSED BUS SOLUTIONS

ABOUT TECHNIBUS Technibus, Inc is a global leader in the supply of metal enclosed bus systems operating for more than 50 years. Our products include Isolated Phase, Non-Segregated,

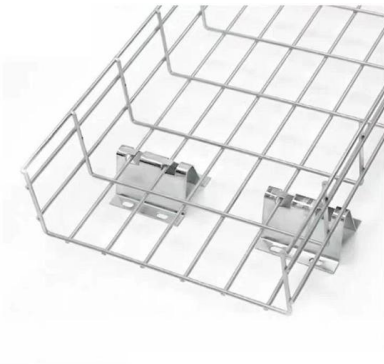

Al Haroj Elictric

Tripoli Libya Libyan company distributor of electrical materials, Medium & High voltage products: Heatshrink splices, Heatshrink termination, Coldshrink splices, Coldshrink termination, Insulation tape

Custom Busbars , ProEV (TM) (An ECI Company)

Discover our high-voltage custom busbars for electric vehicles. Supports a wide range of applications including but not limited to battery packs,



High Voltage Busbars by Intercable Automotive Solutions

One of the signature products developed by Intercable Automotive Solutions are our custom made high-voltage busbars manufactured to client specifications. Busbars



IEC COPPER EDITION

The ABB PMAX (H) IEC Copper range is a 1000 Volt, totally encased, non-ventilated, low impedance sandwich construction, with epoxy resin coated copper conductors.

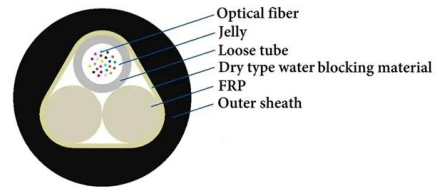

Enclosed Busbar , 660V 400A-5000A Industrial Power

Enclosed Busbar System: 660V AC, 400A-5000A current capacity for power plants & industrial facilities. Achieve reliable power distribution with IP54 protection, CE

High Voltage Equipment Companies And Suppliers Serving Libya

Since 2012 in-Tec Bensheim has been realizing high-voltage cabling concepts. We support our partners from the mobile industry in developing and producing individual solutions for high-voltage connections.

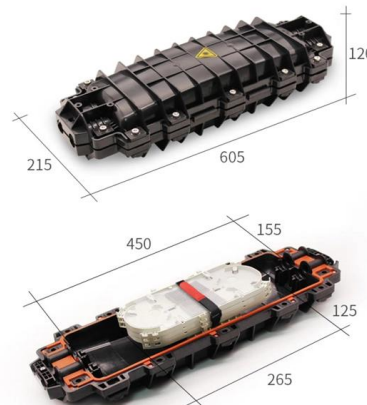



Busbars , Busbars manufacturers & supplier , Eaton

Busbars are metal bars that can be composed of numerous alloys but are most commonly copper or aluminum. Typical busbar applications include switchgear,

ENCLOSED BUS ASSEMBLIES

ENCLOSED BUS ASSEMBLIES GENERAL SCOPE

This section defines low voltage indoor and outdoor busway, fittings and plug-in units for use in AC systems, rated 600 V or less. RELATED

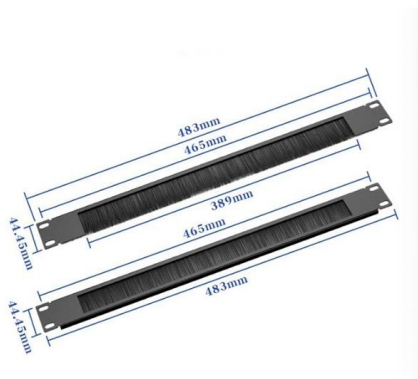

CATALOG WavePro LT Aluminium Busway

Product Overview WavePro LT low-voltage compact busway features rated currents from 250A-4000A, the ability of providing a neutral busbar with 100% and 200% capacity, and has two options available:

Verified Supplier Enclosed Busbar High Voltage & Customizable Size

Selecting the right enclosed busbar system is essential for ensuring the safety, efficiency, and longevity of electrical installations. Enclosed busbars serve as the backbone of power



CATALOG Pmax low-voltage compact bus duct system

The Pmax series compact bus duct system is a safe, reliable, compact, efficient and customized low-voltage energy transmission solution that can fully replace traditional cable, saving time, space and



Home

It is an alternative to traditional cabling and provides numerous advantages to the installer and client including savings on space, time and cost. There are also electrical savings due to reduced losses,



Low and Medium Voltage Bus Duct Types LX and MX

M& I Electric Industries, Inc. manufactures metal-enclosed bus duct assemblies for low and medium voltage power systems. Type LX bus duct is suitable for use on low voltage systems (voltage up to

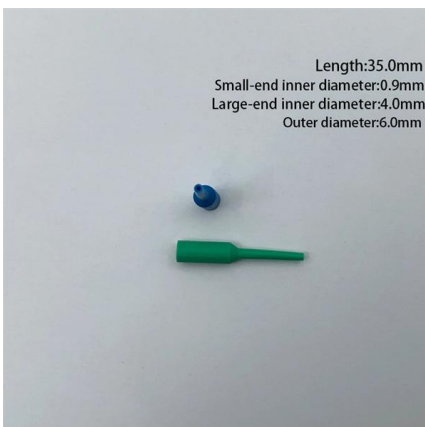



HV Busbar: Copper Busbar with PVC Insulation

Our high-voltage (HV) copper busbars with PVC insulation provide reliable power distribution for high-voltage systems, offering excellent insulation and long-term



Low-voltage busbars, price, to buy a busduct in Moscow,

Busbars 1 kV A bus duct is a system of insulated conduct buses encapsulated in a rigid body. The products are supplied to installation sites in sections. The usage of our bus ducts enables to arrange

Busbars and Connectors in HV and EHV installations

In high-voltage (HV), extra-high-voltage (EHV), and outdoor medium-voltage (MV) systems, bare busbars and connectors are typically used, with conductors



Flexible Copper Busbars for EV Battery Systems

Flexible insulated busbars, using laminated electrolytic copper conductors and heat-shrink insulation, are widely applied in EV battery packs, distribution panels, UPS systems, and transformers, covering



High Voltage Busbars

Learn how TE's high voltage insulators provide robust, light-weight support for pantographs, busbars and other high voltage electric equipment on locomotives, multiple units and high speed trains.



Catalog Extract LV 10 - 04/2023

While the simple exchange of relevant building data between the planners and the facility manager ensures high quality and reduces costs, the digital twin for power distribution fits in seamlessly with

Al Haroj Elictric

Welcome to the web site of the Libyan Supplier of Cable accessories and electrical materials .





Contact Us

For datasheets, pricing, or custom telecom energy solutions, please visit:
<https://www.koskolong.co.za>