



Adam Tas Corridor Energy

Professional Industrial-Grade Switches





Professional Industrial-Grade Switches



Industrial Ethernet Switches , Phoenix Contact

Our Industrial Ethernet Switch portfolio comprises Managed and Unmanaged Switches with Gigabit, PoE, IEC 61850 certification, and for DIN rail mounting.

Enterprise Grade Switches - Niveo Professional

Olympia 2D 1213 NT Hilversum The Netherlands
+31 (0)85 060 45 66 info@niveoprofessional

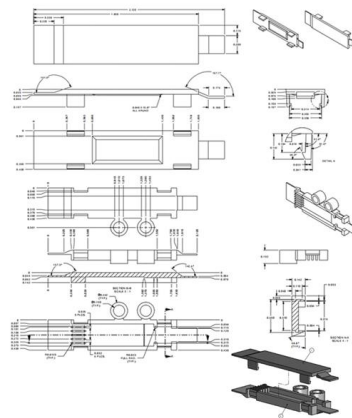

Industrial Ethernet Switches , Industrial Network Switch

Rugged, yet easy to use, Perle has over 734 models of Ethernet switches that feature Industrial Protocol Management support, superior reliability, advanced

Durable Industrial Switches

D-Link's Industrial Switches have industrial-grade resilience to maintain your network uptime despite extreme hot and cold temperature



variances. With Gigabit



- ✓ Slow Axis Aligned (0°) - for standard sensing applications
- ✓ Fast Axis Aligned (90°) - for special modulation applications
- ✓ 45° Axis Aligned - for depolarizer applications



Industrial Ethernet Switches

Provides an overview of deploying PoE in an industrial environment, exploring how this sector can benefit from PoE technology and describing the

Industrial Switches (ISW) , Extreme Networks

Extreme Industrial Switches are an excellent choice for industrial environments, including intelligent transportation systems, utilities, and smart cities. Full redundant ring technology creates fault-

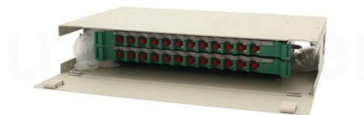

Industrial Ethernet Switches: Benefits, Applications

Discover what industrial grade Ethernet switches are, their unique features, real-world applications, key differences from regular switches, and



What types of industrial-grade switches are available?

Industrial-grade switches are specifically designed for demanding environments, offering features that ensure reliability, security, and longevity in harsh conditions.

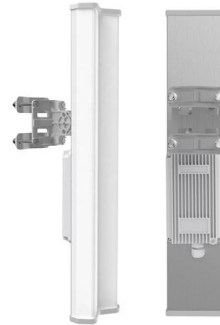

Industrial Network Switches

Industrial network switches are essential components for maintaining robust and efficient communication within industrial environments. Designed to withstand harsh conditions, these switches ensure

Industrial Ethernet Switches

With high-speed 10-GE uplinks, high-wattage PoE options, ultra-low jitter, advanced network security features, and device-to-cloud performance monitoring with the



Industrial Networking Products & Communication Solutions Expert

Maisvch is a leading manufacturer of industrial networking products, including rugged Ethernet switches, gateways, routers, media converters, serial/fieldbus devices.



Guide to implementing Industrial Grade Switches

However, implementing industrial grade switches is a complex process that requires careful consideration and planning. With detailed analysis



Industrial Ethernet Switches

FS Industrial Ethernet Switches with robust design for harsh industrial and outdoor environments subject to vibrations, shocks and extreme temperature fluctuations from -40° to 75° generally.

Industrial Ethernet Switches

Advantech's industrial Ethernet solutions provide an abundance of product options including managed and unmanaged switches, Gigabit Ethernet switches, PoE



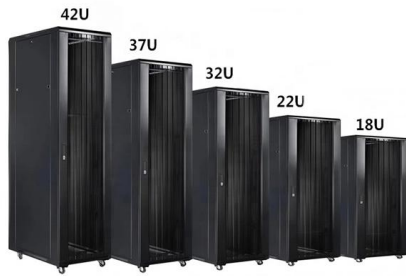

Industrial Grade Switches

Shop for Industrial Grade Switches at Platt 20 Amp, 120/277 Volt, 1HP at 120V or 2HP at 240V-277V, Toggle Single-Pole AC Quiet Switch, Industrial Grade, Self Grounding, External Clamp-Type

Industrial Ethernet Switches

Modernize your operations with Cisco Industrial Ethernet switches: Increase productivity, boost security, and empower industrial AI.

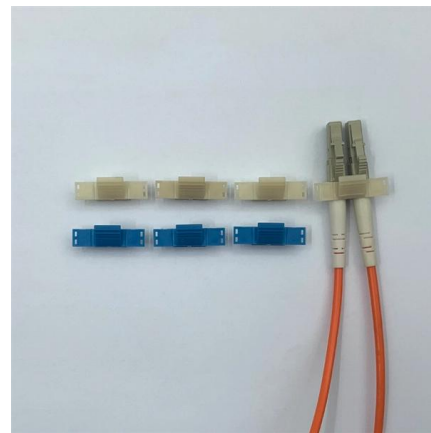

All Industrial Switch Products

Ruijie offers next-generation industrial Ethernet switches designed for harsh industrial environments, providing flexible full-gigabit access as well as 10GE uplink ports, and supporting a wide operating

Industrial Grade Ethernet Switches Catalog , Managed,

Explore our full range of industrial grade Ethernet switches, including managed, unmanaged, PoE, and non-DIN rail models. Designed for reliable performance in



Best Enterprise Switches 2025: Top 5 Network Switches

Most guides to the "best enterprise switches" offer a predictable, high-level list of vendors. You already know the names. But for network architects and

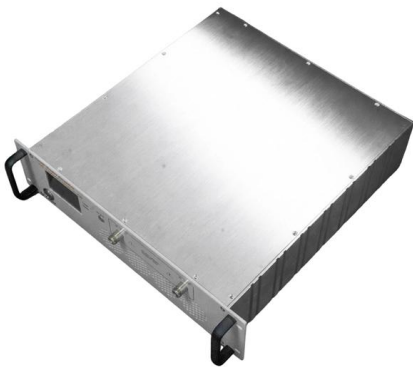

Industrial Switches , Industrial Ethernet Switches , Antaira

Industrial Ethernet Switches Antaira offers a variety of industrial Ethernet switches, including industrial-grade network switches, DIN mount switches, and Ethernet switchboards, that can perform efficiently



Industrial Ethernet Switches

Westermo industrial Ethernet switches are designed to deliver reliable and secure communication in harsh and demanding environments. Our industrial Ethernet





Industrial Ethernet Switches , Phoenix Contact

Our Industrial Ethernet Switch portfolio comprises Managed and Unmanaged Switches with Gigabit, PoE, IEC 61850 certification, and for DIN rail mounting.



All Industrial Switch Products

Industrial Switches Ruijie offers next-generation industrial Ethernet switches designed for harsh industrial environments, providing flexible full-gigabit access as well as 10GE uplink ports, and

How to pick the right Industrial Ethernet Switch for

Industrial Ethernet switches are comprised of managed and unmanaged switches with Gigabit, PoE, and various industry certifications. Featured industrial-grade

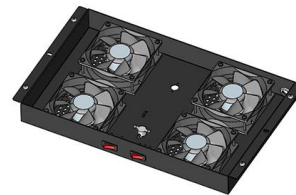

Industrial Ethernet Switches , EtherWAN

Industrial Ethernet switches offer advanced management features with the redundancy and security elements required for essential applications. EtherWAN's lineup includes unmanaged, managed,



How Industrial-Grade Switches Enhance Safety and

The Critical Role of Switches in Industrial Settings
Industrial environments demand high-performance, reliable, and durable switches to

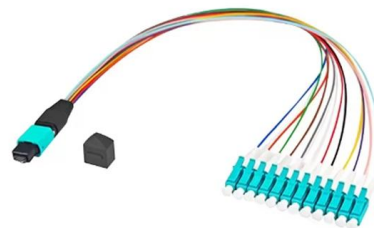

Contact Us

For datasheets, pricing, or custom telecom energy solutions, please visit:
<https://www.koskolong.co.za>