



**Adam Tas Corridor Energy**

# **Recommended manufacturers of fireproof cable trays in Guatemala**





## Recommended manufacturers of fireproof cable trays in Guatemala

---



### Fire-resistant cable tray

Find out all of the information about the NIEDAX product: fire-resistant cable tray . Contact a supplier or the parent company directly to get a quote or to find out a

### Cable Tray In Guatemala, Cable Tray Manufacturers Suppliers

As one of the best Cable Tray Manufacturers in Guatemala, we are trusted by people not only within the boundaries but even beyond that. Our custom-based products are able to match up your distinct needs.



### Cable Trays Fittings In Guatemala, Cable Trays Fittings Manufacturers

Looking to buy a Cable Trays Fittings in Guatemala? Jeetmull Jaichandlall (P) Ltd. is one of the trustworthy Cable Trays Fittings Manufacturers in Guatemala that is here to fulfill all your wire mesh

### Fire Rated Cable Tray, Heavy-Duty Cable Tray Manufacturer

Fire Rated Cable Trays that are crafted from premium materials like stainless steel, galvanized steel, tempered glass, and fire-



resistant polyester fiberglass. Each tray is coated with a specialized fire



### Top Cable Tray Manufacturer & Supplier

We specialize in designing and manufacturing durable cable trays, including those

### Perforated Cable Tray In Guatemala, Perforated Cable Tray Manufacturers

For Perforated Cable Tray : In-House Manufacturing Facility We have a manufacturing facility on-site with modern equipment and advanced technology for creating the top-quality products. Thanks to

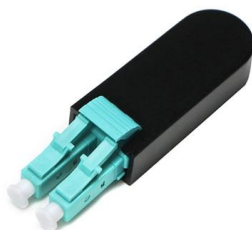
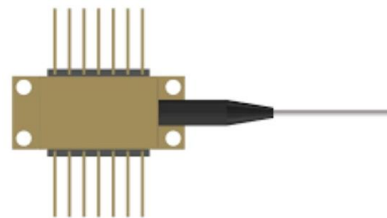

### Top 10 Recommended Fireproof Cable Tray Manufacturers for 2025

This article will outline ten representative manufacturing enterprises that stand out in competition due to their innovative technologies, strict quality control, and diversified services.



## Cable Tray Manufacturers In Guatemala, Electrical Cable Tray Suppliers

Keep your cables safe and organized with our high-quality cable trays. Cable Trays are important for ensuring the protection of the wiring system and supporting insulated electric cables used for



## Perforated, GI, MS & Ladder Type Cable Trays

We meticulously adhere to your specified delivery schedule, providing reliable and prompt service from our facility to your doorstep. Manufacturer Supplier &

## Electrical Cable Tray In Guatemala

We are a one-stop shop for top-notch Electrical Cable Tray in Guatemala. Our cable trays are manufactured from robust materials and rigorously tested to ensure they can withstand even the



## FRP Cable tray

Ferrotech supplies FRP GRP cable trays in varied sizes along several fittings like bends, tees, cross, reducers, etc. for every large or small project. Leading the



## Fireproof Cable Trays Acceptance: Standards for Safety

Ensure safety and durability with this comprehensive guide to fireproof cable trays acceptance. Learn coating processes, inspection standards, and

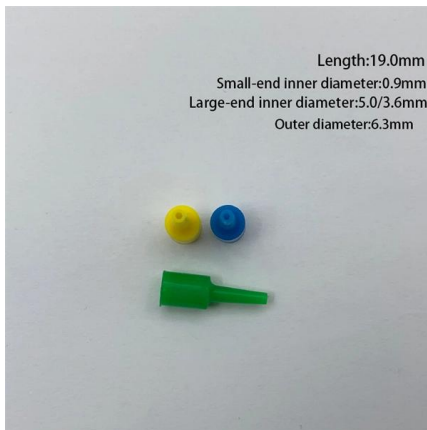

## Top Cable Tray Manufacturers Worldwide: A

Discover leading cable tray manufacturers worldwide, including top companies in Europe, South America, North America, Africa, and Asia. Learn

## Top 5 Cable Tray Manufacturers in North America

Find the leading cable tray manufacturers in North America, with insights into top companies, compliance standards, and essential factors for choosing the right



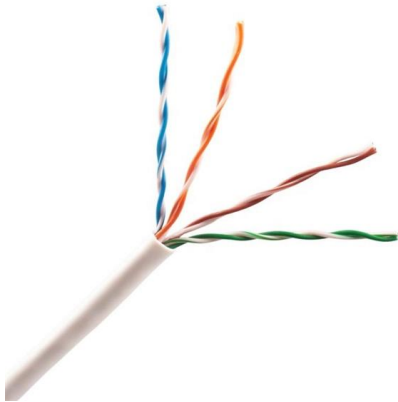

## Top 10 Cable Trays Manufacturers And Suppliers , B2B

Top 10 Cable Trays Manufacturers And Suppliers  
Cable trays, as the name suggests, are structural systems used to hold and support cables and wires in

### Fire stop section of the cable tray and cable management NEMA

The following charts give the number of 3M pillows needed to completely firestop an opening that cable tray passes through.\* Two (2) sticks of moldable putty (part number FSP-MPS) are also needed for

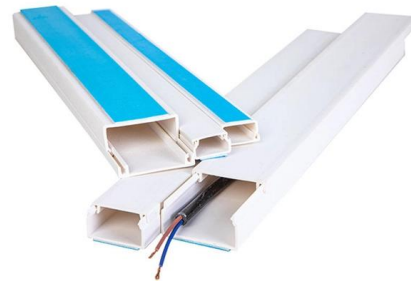

### Cable Tray In Guatemala, Cable Tray Manufacturers Suppliers

Quick Form Cable House has earned loads of appreciation in the market as one of the reputed manufacturers of Cable Tray in Guatemala. Since we are loaded with the right resources, we have

### Interflex USA

Both VIATEC and VIAFIL trays have been rigorously tested and certified, meeting and exceeding the highest standards of the IEC 61537 for cable management systems.

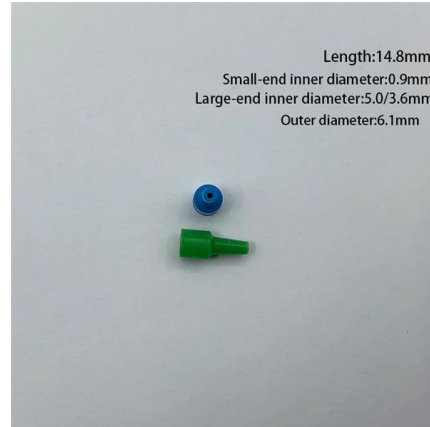

### US4276332A

The advantage of the cable tray system is that repair work and adding new lines is often simplified, due to the easy access to the tray and its contents. A disadvantage is that, in the tray, the fire hazard is

### Fire protection for cables & cable trays , Flamro

Fire protection for cables and cable trays: effective solutions to prevent cable fires Cable systems are found in all buildings nowadays: from industrial plants via

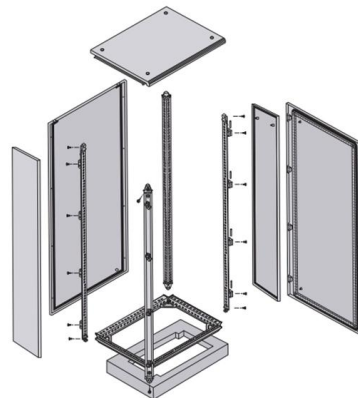

### Electrical Cable Tray In Guatemala

By segregating cables from other building elements, they minimize the risk of electrical hazards and fire. Whether you're working on a new construction project, a renovation, or a retrofit, we, the best Cable



## Cable Tray In Guatemala, Cable Tray Manufacturers Suppliers

Thanks to innovation and improved technology, we have evolved into a one-stop shop for Cable Tray manufacturers. Our highly educated expert closely monitors every aspect of manufacturing and

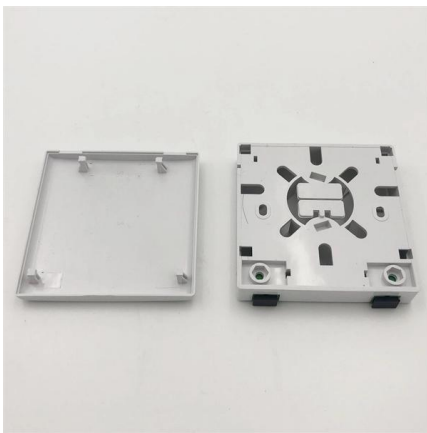

## Industrial Cable Tray Manufacturers , GI, MS & Ladder

Cable Trays Manufacturer, Supplier, and Exporter in India Superfab Inc is a trusted name in the manufacturing, supply, and export of Cable Trays, offering innovative

## UNIFRAX Fyrewrap fireproof Coating for Cables, Cable

Our company's cable insulation, cable tray, and pipeline fireproof materials adhere to the global standards recognized by FM (Factory Mutual Insurance Company).



## Contact Us

---

For datasheets, pricing, or custom telecom energy solutions, please visit:  
<https://www.koskolong.co.za>