



Adam Tas Corridor Energy

Senegal Consulting on Network Security Equipment 2 5G





Senegal Consulting on Network Security Equipment 2 5G



Network Security Dakar , Network Security Solutions Dakar, Senegal

From medium businesses to global enterprises, we work with many customers across Senegal and Dakar to solve their network security concerns, increases support and help to move their business

Security , Risk Solution Africa , Dakar, Senegal

Risk Solution Africa concept was established in 2019 by two co-founders and shareholders in specialized security risk and crisis management solutions. The

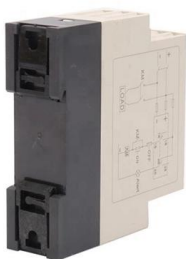

Managed Security Services in Sénégal , Secmentis Sénégal

Secmentis can manage your IT security devices for your Sénégal business, such as firewalls, VPN gateways, and more, for you.

Proposal for a Deployment of a Non-standalone 5G

To achieve this, we propose an architecture and deployment of 5G in non-standard mode for



developing African countries where 4G deployment is in



Data Center Consulting Design Owners Rep Dakar Senegal SN

DC Deployed is a data center consulting firm who provides expert guidance in the design, construction, and program management of data centers in Dakar, Senegal, SN.



Health Technology Management (HTM) & Lifecycle Consulting in Senegal

Health Technology Management (HTM) and lifecycle consulting services in Senegal offer significant benefits to a diverse range of stakeholders within the healthcare ecosystem. These services are



SEN GLOBAL NETWORK SERVICES

À travers nos divisions de conseil, d'intégration, de bureau d'études en fibre optique et nos compétences de production Mise en place de réseaux



Senegal Enterprise Network Equipment Market (2024-2030) , Trends

Senegal Enterprise Network Equipment Market is expected to grow during 2024-2030

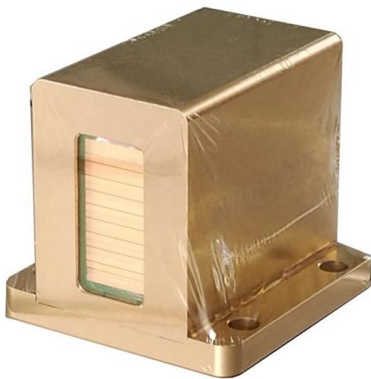

The Critical Communications Review

The Government of Senegal, through the Ministry of the Interior, has awarded Motorola Solutions a contract to deploy a nationwide secure and resilient communications ASTRO P25 radio network to

Senegal Enterprise Network Equipment Market (2024-2030) , Trends

Senegal Enterprise Network Equipment Industry Life Cycle Historical Data and Forecast of Senegal Enterprise Network Equipment Market Revenues & Volume By Type for the Period 2020-2030

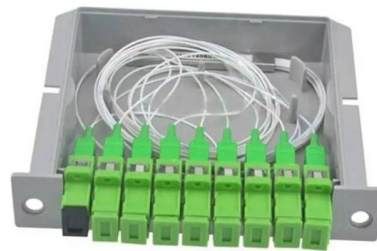

sensbcs

Senegal is undergoing a significant digital transformation driven by the "Digital Senegal Initiative." This initiative aims to enhance the country's telecommunications and IT sectors, fostering economic



ACCUEIL

Experts en réseaux Wi-Fi professionnels, sécurité informatique et vidéosurveillance, Danewell Solutions accompagne entreprises et institutions au Sénégal.



Network Security

This figure highlights the investment made by businesses in Senegal to ensure robust network security measures are in place.

Telecom network security solutions

SecurityGen is your trusted partner for telecom network security solutions. We offer cyber security in telecommunications that covers all aspects of telecom fraud





Senegal Network Security And Cyber Risk Management Market (2025)

Historical Data and Forecast of Senegal Network Security And Cyber Risk Management Market Revenues & Volume By Security Information and Event Management (SIEM) for the Period 2021-2031

IMSI Catcher Nigeria , 2G/3G/4G/5G IMSI Catchers Senegal

Advanced IMSI catcher and interception systems for 2G/3G/4G/5G, including portable, backpack, vehicle, and drone-mounted solutions. Specialising in TRS Tactical Reconnaissance, GSM, wi-fi, and

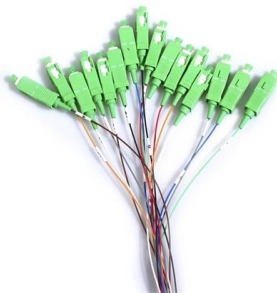

Network Security

However, Senegal's growing market and increasing revenue indicate its potential to become a significant player in the network security landscape.

Microsoft Word

To guarantee this digital confidence, the Government of Senegal needs to ensure it has the frameworks, tools, knowhow, resources and capacities required not just to eliminate the vulnerabilities in





Security Services

Senegal: In Senegal, the revenue in the Security Services market is estimated to reach US\$*****m in ****. Definition: Security services refer to an overarching processing or a wide range of

IEEE Paper Template in A4 (V1)

5G is deployed in standalone or non-standalone mode and is an environment that combines many networks with different protocols and requirements thanks in part to software engineering.

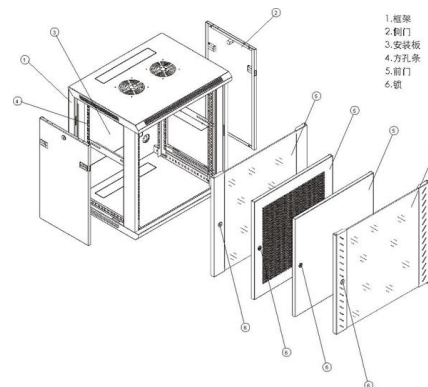

SENEGAL'S COUNTRY STRATEGY PAPER (2021-2025)

Senegal also intends to extend its motorway network to more than 900 km by 2030, with projects such as the Kaolack - Tambacounda (260 km) and Diourbel - Fatick (70 km) sections.

Senegal

The connection is to either the low- or medium-voltage distribution network and is either overhead or underground, whichever is more common in the area where the warehouse is located and requires

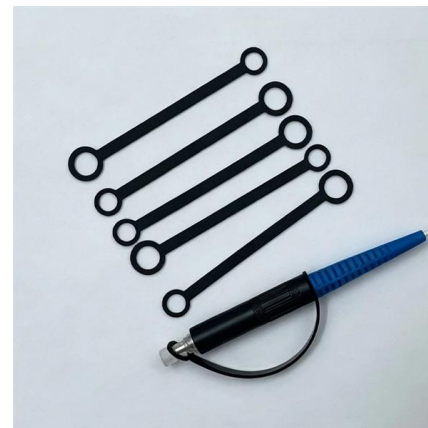



Sonatel Launches 5G Mobile Services in Senegal -

Sonatel (Orange) launches 5G mobile services in Senegal, promising faster speeds and enhanced connectivity. Learn more about the network coverage, benefits, and how this impacts the

Cyber Security, Cyber Threat Intelligence, Penetration Testing

Secmentis Sénégal is a cyber security consultancy specializing in penetration testing, threat intelligence, and proactive defense for your entire IT infrastructure.

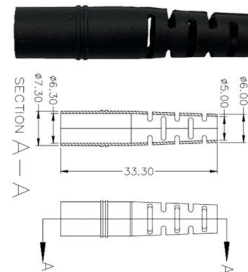

Mobile networks, SIM cards, and home internet in Senegal

Internet and mobile connectivity in Senegal: SIM cards, fiber plans, mobile networks, public WiFi, internet speeds, and what expats need to know about outages.

Senegal

These have been formalised in a strategic plan entitled "Digital Senegal 2025", part of the "Plan for an Emerging Senegal." Moreover, the country's political and economic stability has helped make it a



Senegal: Sonatel confirms readiness to deploy 5G

In Senegal, Sonatel has covered 89% of the population with its 4G network. Currently, the company is seeking to move to 5G. Under this plan, it has recently conducted a second test of its 5G network in

Senegal Wireless Network Security Market (2025-2031) , Value

Senegal Wireless Network Security Industry Life Cycle Historical Data and Forecast of Senegal Wireless Network Security Market Revenues & Volume By Solutions for the Period 2021-2031



Contact Us

For datasheets, pricing, or custom telecom energy solutions, please visit:
<https://www.koskolong.co.za>