



Adam Tas Corridor Energy

Steel cable trays and metal wire troughs





Steel cable trays and metal wire troughs



Cable Tray Ladder Trunking Wire Basket Installation

Resources For Electrical & Electronic Engineers
Cable Tray Ladder Trunking Wire Basket
Installation Guidelines What Are Cable Trays? An
assembly of

Cable Tray

Cable Tray Cable trays are mechanical support systems that provide a rigid structural system for electrical cables, raceways, and insulated conductors used



Wireways

Wireways are troughs with hinged or removable covers for routing and protecting electric wire and cable in permanent, whole-facility wiring installations.

Armorduct Systems Ltd , Manufacturing Cable

Armorduct Systems are a UK manufacturer of steel cable management systems including cable



trunking, tray, basket, floor boxes, power track & more. Wide

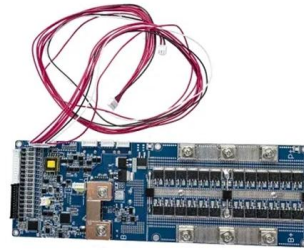

Trough Type Cable Trays

Types of Trough-Type Cable Trays A trough-type cable tray is one of the most versatile and widely used cable management solutions in industrial and commercial environments. Designed to support and

Solar Wire Management: Complete Guide To PV Cable

Comprehensive guide to solar wire management covering installation, products, safety, and cost optimization. Expert insights for PV professionals and



Suppliers in Turkey , B2B Marketplace , Kompass

Specializes in manufacturing of cable tray systems (cable trays, ladders, trunkings, wire mesh cable trays, marine type cable ladder and tray systems) mechanical supports, cantilever brackets, strut



Cable Trays Manufacturers and Suppliers

Buy the best selection of high-quality Cable Trays at wholesale prices from leading international manufacturers, suppliers, exporters, and distributors at Tradewheel .



Cable Tray , EAE Electric , Medium & heavy duty cable

Explore EAE Electric's medium and heavy-duty cable tray systems designed for optimal cable management and durability in industrial and commercial applications.

Cord Troughs , McMaster-Carr

Choose from our selection of cord troughs, including cable and hose trays, steel formable cable and hose trays, and more. Same and Next Day Delivery.

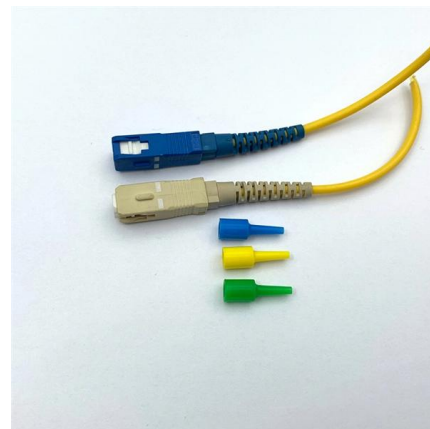

Cord Troughs , McMaster-Carr

Cut, bend, and connect these wire mesh tray systems to route cable and hose in configurations such as curves, slopes, and tees. They are a lightweight option for organizing bundles of cable and hose

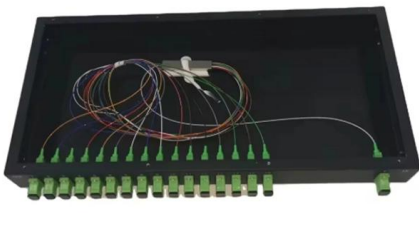

Wireways Selection Guide: Types, Features,

Wireways are designed to protect cables from environmental contaminants such as dust, dirt, oil, and moisture. Wireways--sometimes known as "troughs" or



Top 50 Cable Tray Manufacturers in the US

1. MP Husky Cable Tray & Cable Bus Established in 1955, MP Husky is a leading North American manufacturer of UL- and CSA/NEMA-compliant cable

Wiring Trough Enclosures , Wireway Boxes , RSP Supply

Explore wiring trough enclosures and electrical wireway boxes for protected cable routing, terminations, and junctions.

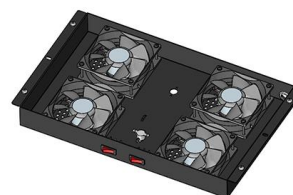



Cable Trays , Cable Management Trays



Shop Cable Trays, Wire Trays & Cable Baskets, Steel & Stainless Steel Cable Trays. Professional Cable Management with Fast & Free Delivery.

Cable Troughs Manufacturers and Suppliers in the USA and Canada

Cabletroughs are available in steel, stainless steel & aluminum materials & in metal tubing dia. ranging from 0.125 in. to 1 in. Capabilities including CNC wire bending, wire forming, swaging,

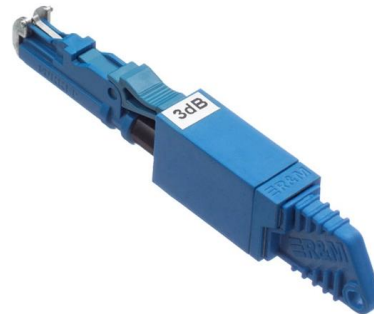

Cable Tray Market , Global Market Analysis Report

The cable tray market is projected to grow from USD 4.3 billion in 2025 to USD 5.4 billion by 2035, at a CAGR of 2.4%. Metal will dominate with a



Product Catalogue Cable Management Solutions

Delivering engineered solutions in cable management ABB manufacturers a comprehensive range of cable tray systems and solutions including cable ladder, perforated tray, channel tray and metal



Cable Trough , Safe & Secure Cable Protection

Cable troughs are convenient systems for providing safe, secure and practical management of electrical cables, pipes and other service



Metal cable trunking for every application and every requirement

o

The perfectly coordinated range includes well-proven solutions such as the versatile Industrial-Trunking, compact PIK-Trunking and the open Wire-tray Trunking to ensure you always have just the right

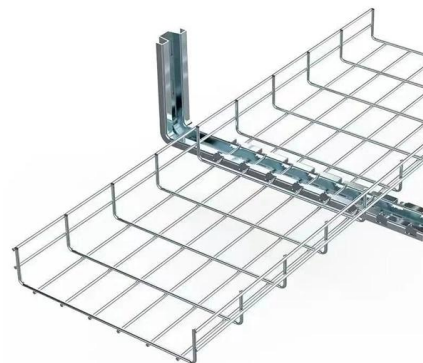

Cable Trough , Safe & Secure Cable Protection

HAURATON drainage channels have been cleverly adapted with the inclusion of solid covers and cable trays as a floor-laid cable routing





Wire Mesh Cable Trays

Explore Spina Group wire mesh cable trays - metal tray systems for industrial installations. Durable, ventilated, and easy to assemble for multiple sectors.

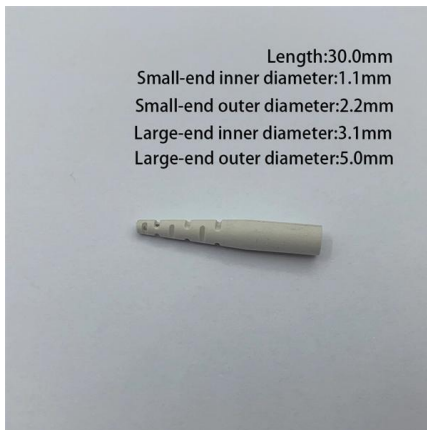

Cable Trough , Safe & Secure Cable Protection

HAURATON drainage channels have been cleverly adapted with the inclusion of solid covers and cable trays as a floor-laid cable routing

Contact Us

For datasheets, pricing, or custom telecom energy solutions, please visit:
<https://www.koskolong.co.za>