



**Adam Tas Corridor Energy**

# **Wiring Method for Paraguayan Level 3 Distribution Box**





## Overview

---

Ensure safe placement: install in dry, accessible areas with good ventilation and at appropriate height (typically ~1. Whether in a home or an industrial facility, this box keeps your electrical setup organized, functional, and efficient. 1) Generally, the incoming line of power distribution box adopts five wire system, that is, a, B and C three-way phase line (the general color is yellow, green and red), one way zero line (the color is light blue) and one way ground line (the color is yellow with green stripes). Presently it comprises 22 countries (Austria, Belgium, Czech Republic, Denmark, Finland, France, Germany, Greece, Hungary, Iceland, Ireland, Italy, Luxembourg, Malta, Netherlands, Norway, Portugal, Slovakia. Hierarchical and Branch Circuit Distribution (1) Power distribution from the primary main distribution board (distribution cabinet) to secondary distribution boards can be branched; that is, one main distribution board may supply.



## Wiring Method for Paraguayan Level 3 Distribution Box

---

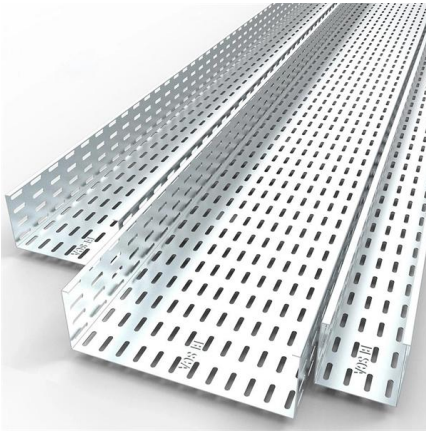

### How to Install a Cable Distribution Box Safely and

Cable distribution box can be customized according to special application requirements, such as in high temperature, high humidity, corrosive or

### Electrical installation handbook

In particular, it is applicable to any apparatus used for production, conversion, transmission, distribution and use of electrical power, such as machines, transformers, devices, measuring instruments,



### Paano Mag Set Up Ng 2 to 3 Rows Na Distribution Box

Electrical wiring connection Electrical wiring installation Electrical devices tutorial Power tools review Hand tools review New electrical devices Thanks for Watching and Hope you enjoy it.



### Size determination, installation method and wiring mode

Next, let's introduce the wiring mode, installation method and size determination of the



distribution box, For your reference. (1) Wiring method of distribution box.



### Electric Panel Installation Method Statement

This document provides a method statement for installing and terminating electric panels and distribution boxes. It outlines 4 steps: 1) Pre-installation preparation

### How to determine the size, installation method and

1) The distribution system shall be equipped with indoor main distribution box and outdoor distribution box, or each distribution box of outdoor main distribution box

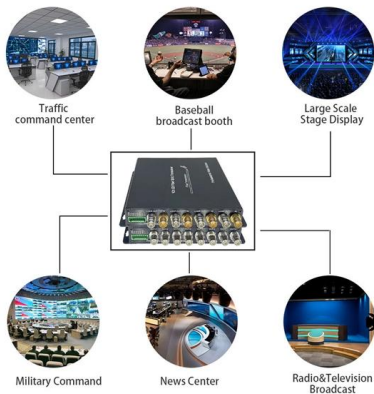

© 2021 TheAuthor(s). Published by Elsevier Inc. This is

Distribution level electric current consumption and meteorological data set of the east region of Paraguay



## Step-by-Step Guide to Wiring a 3 Phase DB Box

Learn about the wiring process for a 3 phase distribution board (DB) box, including the necessary steps and safety precautions. Understand how to connect the

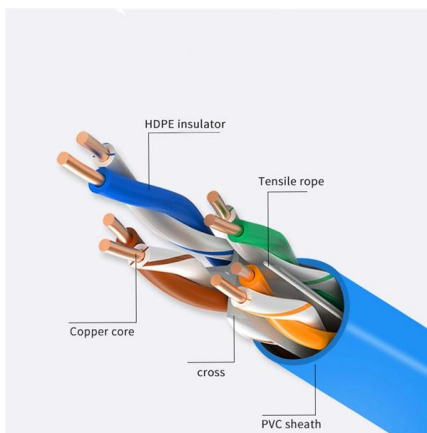

## Essential Rules for 3-Level Electrical Distribution

Follow key principles: no cross-level wiring, one machine-one switch,  $\leq 30\text{m}$  box spacing, dry/ventilated installation for safe distribution.

## GOVERNMENT OF INDIA

In case of EPC contracts, the firm shall be responsible for design of the works and preparation of the related drawings, execution drawings of work including distribution diagram/s, wiring diagram/s and

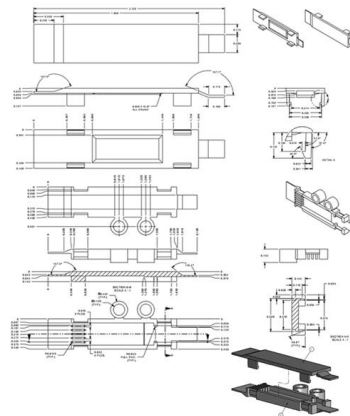

## How To Make 3 Phase Distribution Board In MCCB Wiring Diagram , 3

This video shows 3 Phase Distribution Board In MCCB Wiring Diagram. 3 phase distribution (DB) box 3-phase rack PDU, is spread evenly across all three phases (L1/L2, L2/L3, and L3/L1). It can be



## 2 0 1 3

Planning of Electrical Installation Electric Power Distribution & Wiring Metallic Conduit Wiring System Non-metallic Conduit Wiring System Trunking Cable Management System M.V. Panel, D. B., Rising

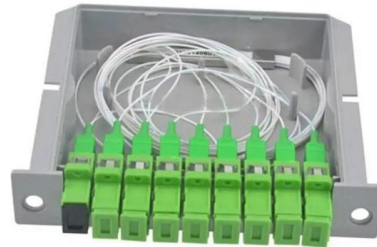

## Requirements And Specifications For Installation Of

The installation requirements and specifications of Distribution box involve many aspects, including site selection, fixing method, wiring specifications

## Understanding Circuit Breaker Wiring Configurations in

Correct wiring methods for circuit breakers within distribution boxes are fundamental to ensuring electrical safety and compliance with established codes.





## **(PDF) Distribution level electric current consumption and**

PDF , This paper presents a data set with information on meteorological data and electricity consumption in the department of Alto Paraná,

## **Method Statement for Installation & Testing of Electrical**

This method statement will help the electrical engineers and supervisors for the installation of distribution board for an electrical project. Additionally site team will

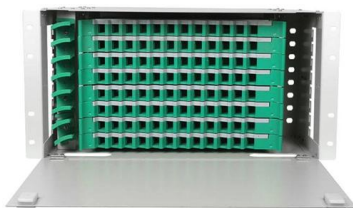

## **Distribution Box Wiring Steps**

?Wiring Direction?: Wiring between the main circuit breaker and each branch circuit breaker in the box generally goes on the left, and the wiring out of

## **Electric Panel Installation Method Statement**

METHOD STATEMENT FOR Electric panel and distribution box installation and termination - Free download as PDF File (.pdf), Text File (.txt) or read online for



### 3 Wire Wiring Diagram Explained and Setup Guide

Learn how to read and create a 3 wire wiring diagram for various electrical systems. Step-by-step guide with tips for proper wiring connections and safety.



### Distribution Board Installation Guide , PDF , Electrical

The document is intended to help electrical engineers and supervisors install distribution boards for electrical projects according to contract requirements and



### Low-voltage distribution networks

In European countries the standard 3-phase 4-wire distribution voltage level is 230/400 V. Many countries are currently converting their LV systems to the latest IEC standard of 230/400 V





## How to Install a Distribution Box--A Comprehensive

Whether you are an electrical contractor or a construction brigade, knowing how to properly and safely install distribution boxes is the basis of

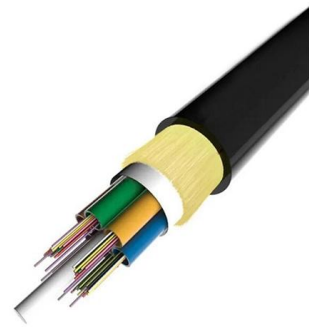

## Contact Us

---

For datasheets, pricing, or custom telecom energy solutions, please visit:  
<https://www.koskolong.co.za>