



**Adam Tas Corridor Energy**

# **XI28 distribution box dimensions**





## XI28 distribution box dimensions

---

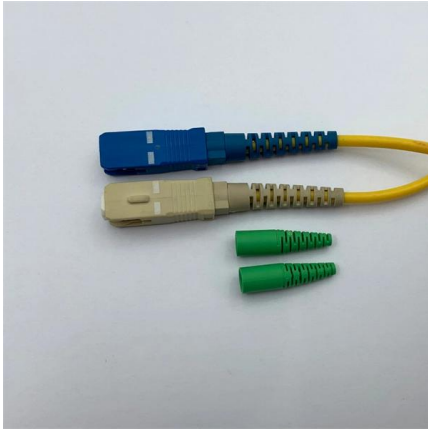

### Fiber Distribution Box

Overview The PPC Fiber Distribution Box is a multi-purpose, robust enclosure made with high-grade industrial plastic. The box can be used as a 16-core splitter enclosure or distribution unit based on

### Area distribution boxes with connectors

The area distribution box associated with the copper or optical feedthrough sockets allows total flexibility: the connections close to the workstation are centralised.



### XL -N 630 3-phase distribution boards

3-phase distribution boards for moulded case circuit breakers, DRX or DPX3 IP 40 (IP42 with the kit Cat.No 6 045 68) - IK 08 with door Conform to standard IEC 61439-2. Type tested; tested and



## Comprehensive Guide to Septic Distribution Box Dimensions

Discover key dimensions, installation tips, and maintenance practices for septic distribution



boxes to ensure optimal performance.



### Distribution Box

Distribution Box Product Description: Place of Origin: Guangdong, China Model No: DX16-A113 Size: 13 ways, 1 row Specification: 230V/ 400V, 125A, 50 Hz / 60Hz

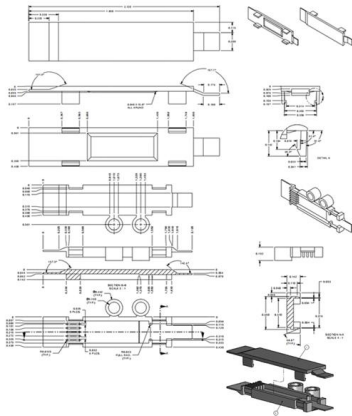

### Distribution Box Dimensions Technical Data Model CSD-B01-CB4A

Distribution Box Technical Data Dimensions M18 x 12 Pin Connector Pin Out Subject to modifications without notice Mikrosen Control Devices Pvt. Ltd



### SELECT YOUR DISTRIBUTION SYSTEM

Distribution is an essential function for the electrical panels, as well as for control and circuit protection. As well as purely technical factors (intensity, number of outputs, etc.), the choice of a distribution



## **XL-21 low voltage electric power switchgear electrical distribution box**

XL-21 low voltage electric power switchgear is a cutting-edge solution for efficient and reliable power distribution. With its advanced technology and superior performance, it ensures seamless operation

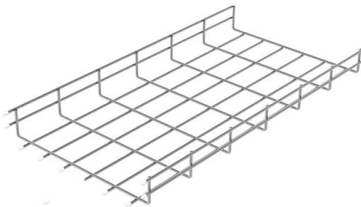

## **Distribution Boxes Technical Data**

PDF file

## **CATALOGUE General purpose enclosures Heavy duty and industrial**

Polycarbonate boxes are available with a smooth surface (one single entry) or with multiple metric cutouts. Boxes are available with a smooth surface or with multiple metric cutouts. Opaque gray or transparent

## **XL-21 Low-Voltage Power Distribution Box , 380V 800A**

Fulleto Electric manufactures the robust XL-21 low-voltage power distribution box. Rated for 380V 800A, it offers superior dustproof protection and safety for



## **Electrical Control Panels & Distribution Boxes: Sizes,**

Introduction Electrical control panels and distribution boxes are the backbone of modern electrical systems. From powering homes and



industrial



### METAL DISTRIBUTION BOX

VM-DBM range of surface type metal distribution boxes or metal clad consumer units are available in up to 13\* different sizes to suit your needs.

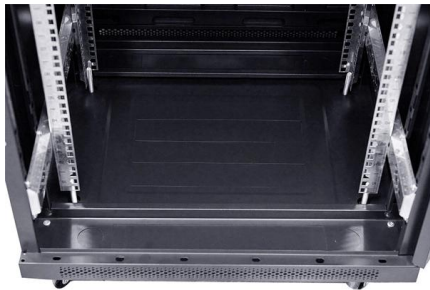

### XL3-N 250 3-phase distribution boards

Flush-mounting distribution boards 1: For XL3-N 250 distribution boards only

### Pitbull Compact Loader XL28-45CRT Closed cabine

Specifications Pitbull Compact Loader XL28-45CRT Closed cabine Overall length with tray 4239 MM Overall length without tray 3530 MM





## High Quality MCB Distribution Box Size /

3.Products' Dimension: 1) Close connection. Neutral wire line bank and earthing wire line bank both adopt close type with a steady overall structure, which makes

## Distribution Box

Metal Distribution Box Features Continuously welded seams Foam-in-place seamless gasket 120-degree opening heavy-duty industrial hinges IP66 protection rating against dust and water according



## one distribution boxes

It allows the distribution of low voltage current in a zone equipped with 1 to 12 sockets and is connected to the patch panel or cabinet by a maximum of 6 or 12 links. The self-assembly zone

## Final\_product\_book\_12\_curve

GSDB-4030 400x300x190 3 Phase Service Connection Distribution Box/ ABC Distribution Box 11.



### Ex9xg Catalogue 2024

5. Application The Ex9XG series plastic distribution box is suitable for construction sites, outdoor charging stations parking lots, shops, gardens, bathrooms and other places, electricity meters and



### How to choose a distribution box of the right size for a project based

If you're like most electrical professionals, picking the right distribution box for your project can feel like navigating a maze. I've been in those shoes - staring at spec sheets, worrying about



### Eaton XBoard Distribution Box

The Power of Eaton Eaton's power distribution systems are designed to be as compact and energy efficient as possible while easy access for installation, operation and maintenance. Medium and Low





## XL<sup>3</sup> 125

With their optimised dimensions and modularity, XL<sup>3</sup> 125 enclosures allow a distribution up to 125 A, thanks to a capacity of 18 modules per row, covering from 1 to 4 rows. They also offer the possibility

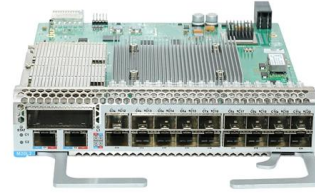

## XL-21 power distribution cabinet

XL-21 power distribution cabinet Cabinet front door installed ammeter, voltmeter and the signal lamp, button, selector switch and other components. The main

## Instruction Sheet Dimensions LEDpod XL28 Flat · 42VD

Dimensions Ø 33 · h 32 hand tighten security screws + Other sizes available on request

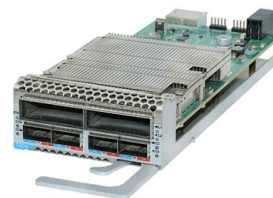

## Distribution Box

Our distribution boxes are perfect for industrial environments, catering to automation, robotics, and processing facilities. They provide cost-effective solutions through automated dispensing and



### **Pitbull XL28-45CRT Wheel Loader Specs & Dimensions (2024)**

What are the transport dimensions of the Pitbull XL28-45CRT wheel loader? The Pitbull XL28-45CRT has a transport length of 3.1 meters, a transport width of 1.22 meters, and a transport height of 2.2



### **XL-21 Series Low Voltage Power Distribution Cabinet**

The XL-21 low-voltage power distribution cabinet is suitable for three-phase four-wire systems with AC voltages up to 500V. It is primarily used for power.

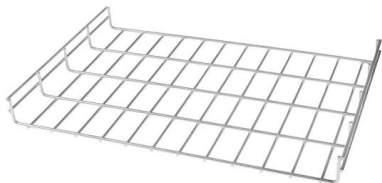

### **XL-21 AC Distribution Box Manufacturer , Factory Direct**

The XL-21 series power distribution box is one of the widely used power control and distribution equipment in low-voltage distribution systems. Due to its easy installation, flexible use, easy





### **Distribution box catalogue , PDF**

Dimensions included are length, width, and height. - Download as a PDF or view online for free.

## **Contact Us**

---

For datasheets, pricing, or custom telecom energy solutions, please visit:  
<https://www.koskolong.co.za>